

Alpha COND 1000

Controller/Transmitter
uS/cm / mS/cm / °C



ROSS and the COIL trade dress are trademarks of Thermo Fisher Scientific Inc. U.S. patent 6,793,787.

AQUAfast, Cahn, ionplus, KNIpHE, No Cal, ORION, perpHect, PerpHecT, PerpHecTion, pHISA, pHuture, Pure Water, Sage, Sensing the Future, SensorLink, ROSS, ROSS Ultra, Sure-Flow, Titrator PLUS and TURBO2 are registered trademarks of Thermo Fisher.

1-888-pHAX-ION, A+, All in One, Aplus, AQUAsnap, AssuredAccuracy, AUTO-BAR, AUTO-CAL, AUTO DISPENSER, Auto-ID, AUTO-LOG, AUTO-READ, AUTO-STIR, Auto-Test, BOD AutoEZ, Cable-Free, CERTI-CAL, CISA, DataCOLLECT, DataPLUS, digital LogR, DirectCal, DuraProbe, Environmental Product Authority, Extra Easy/Extra Value, FAST QC, GAP, GLPcal, GLPcheck, GLPdoc, ISEasy, KAP, LabConnect, LogR, Low Maintenance Triode, Minimum Stir Requirement, MSR, NISS, One-Touch, One-Touch Calibration, One-Touch Measurement, Optimum Results, Orion Star, Pentrode, pHuture MMS, pHuture Pentrode, pHuture Quatrode, pHuture Triode, Quatrode, QuiKcheK, rf link, ROSS Resolution, SAOB, SMART AVERAGING, Smart CheK, SMART STABILITY, Stacked, Star Navigator 21, Stat Face, The Enhanced Lab, ThermaSense, Triode, TRIUMpH, Unbreakable pH, Universal Access are trademarks of Thermo Fisher.

Guaranteed Success and The Technical Edge are service marks of Thermo Fisher.

PerpHecT meters are protected by U.S. patent 6,168,707. PerpHecT ROSS electrodes are protected by U.S. patent 6,168,707. ORION Series A meters and 900A printer are protected by U.S. patents 5,198,093, D334,208 and D346,753. ionplus electrodes and Optimum Results solutions are protected by U.S. patent 5,830,338. ROSS Ultra electrodes are protected by U.S. patent 6,793,787. ORP standard is protected by U.S. patent 6,350,367. No Cal electrodes are protected by U.S. patent 7,276,142. © 2009 Thermo Fisher Scientific Inc. All rights reserved. All trademarks are the property of Thermo Fisher Scientific Inc. and its subsidiaries. The specifications, descriptions, drawings, ordering information and part numbers within this document are subject to change without notice. This publication supersedes all previous publications on this subject.

Preface

This manual serves to explain the use of the Alpha COND 1000 process controller/transmitter. The manual functions in two ways, firstly as a step by step guide to help the user operate the instrument. Secondly, it serves as a handy reference guide. This instruction manual is written to cover as many anticipated applications of the Alpha COND 1000 process controller/transmitter. If you have doubts in the use of the instrument, please do not hesitate to contact the nearest Authorized Distributor.

Thermo Scientific will not accept any responsibility for damage or malfunction of the unit due to improper use of the instrument.

The information presented in this manual is subject to change without notice as improvements are made, and does not represent a commitment on part of Thermo Scientific.

Copyright ©2009

All rights reserved.

Safety Information

The Controller/ Transmitter shall be installed and operated only in the manner specified in the Instruction manual. Only skilled, trained or authorized person should carry out installation, setup and operation of the instrument.

Before powering up the unit, make sure that power source it is connected to, is as specified in the top label. Failure to do so may result in a permanent damage to the unit.

The unit has live and exposed parts inside. If it has to be opened, make sure that the power to the unit is off and disconnected.

The unit is Fuse protected. In the event the fuse has to be replaced, use only those as specified in the manual.

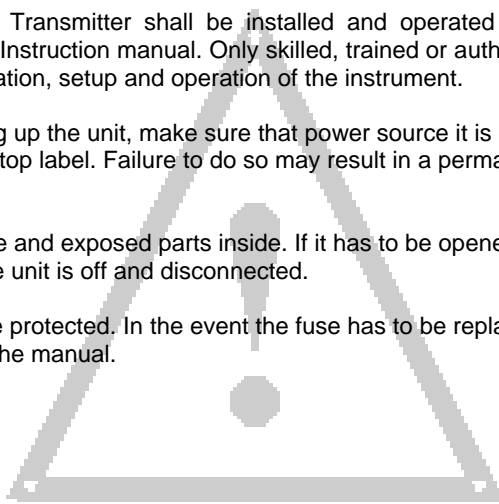

TABLE OF CONTENTS

1	INTRODUCTION	1
1.1	Description of Unit.....	1
1.2	Applications	1
2	ASSEMBLY AND INSTALLATION	2
2.1	Measurement and Control System.....	2
2.2	Unit Dimensions.....	Error! Bookmark not defined.
3	ELECTRICAL CONNECTION	3
3.1	Connection Diagram	3
3.2	Back Panel.....	4
4	OVERVIEW	5
4.1	Keypad and Display	5
4.1.1	Keypad	5
4.1.2	Display.....	5
4.2	Function Groups	6
4.2.1	How to view operating parameters without access to change them:.....	6
4.3	Control Concept.....	7
5	MEASUREMENT	8
5.1	Display in Measurement mode.....	8
5.1.1	Check electrode performance	8
5.1.2	Checking set points	8
5.2	Security Codes.....	9
5.2.1	How to enter and change parameters in Calibration mode.....	9
5.2.2	How to enter and change parameters in Advanced Setup mode	9
6	CALIBRATION MODE	11
6.1	Conductivity Calibration	11
7	ADVANCED SET-UP MODE	13
7.1	Temperature Coefficient sub-function	13
7.1.1	Selecting Pure-water or Linear Temperature Coefficient ..	13
7.2	Temperature Calibration (ATC mode only)	14
7.2.1	Setting Manual Temperature Compensation	14
7.3	Control Relay A/Control Relay B (SP1/SP2) sub-function	15
7.3.1	Entering the Set point 1 (or Set point 2) sub-function	15
7.3.2	Selecting the set point values.....	15
7.3.3	Choosing High or Low set points.....	16
7.3.4	Selecting a hysteresis (dead band) value	16
7.3.5	Setting an on-delay time lag.....	17
7.3.6	Setting an off-delay time lag.....	17
7.4	Controller (Cnt) sub-function.....	18

7.4.1	Entering the Controller sub-function.....	18
7.4.2	Choosing the controller type (limit or proportional)	19
7.4.3	Choosing Break/Make Contact Relay Type	19
7.4.4	Selecting Proportional Range Value, Xp.....	20
7.4.5	Maximum Pulse Length (tPL) or Maximum Frequency (FPF) 20	
7.5	Measurement Range sub-function	21
7.5.1	Selecting the Measuring Range sub-function	21
7.6	Current Output (rng) sub-function	22
7.6.1	Entering current output sub-function	22
7.6.2	Choosing the output type	22
7.6.3	Selecting Conductivity value at 0(4)mA.....	22
7.6.4	Selecting Conductivity value at 20mA.....	23
7.7	Configuration (ConF) sub-function.....	23
7.7.1	Entering the Configuration sub-function.....	23
7.7.2	Selecting Filter Function and the Alarm or Wash Function 23	
7.7.3	Selecting the alarm time lag	24
7.7.4	Selecting steady or pulse contact for the alarm relay	24
7.7.5	Wash contact (if the relay 3 is set to Wash).....	25
7.7.6	Input Line Resistance Adjust.....	25
7.7.7	Reverting to factory default settings	25
7.8	Calibration (CAL) sub-function.....	26
7.8.1	Entering Calibration mode from Advanced Set-up mode..	26
8	AUTO/MANUAL MODE	27
8.1	Auto mode (mode after switch-on).....	27
8.2	Manual mode	27
9	TECHNICAL SPECIFICATIONS	28
10	ACCESSORIES	29
11	GENERAL INFORMATION.....	29
11.1	Warranty	29
11.2	Packaging	29
11.3	Return of Goods.....	29
11.4	Guidelines for Returning Unit for Repair	30
12	APPENDICES	30
12.1	Appendix 1 – Jumper Positions.....	30
12.2	Appendix 2 – Measurement Ranges available in the Controller.....	31
12.3	Appendix 3 – Conductivity at Related Temperature Coefficients (25 °C) 31	
12.4	Appendix 4 – Conductivity of Various Aqueous Solutions at 25 °C	33
12.5	Appendix 5 - Simple Explanation on the Function of Hysteresis.....	34
12.6	Appendix 6 – General Instructions Concerning Controller Setting	35

1 INTRODUCTION

1.1 Description of Unit

Thank you for purchasing the ¼ DIN Alpha COND 1000 series Conductivity process controllers. This unit is used for measuring the Conductivity of a solution, either in micro-Siemens or milli-Siemens, one at a time, and the operational mode is switchable from the menu. You can use this unit to measure Conductivity with limit control. This controller has many user-friendly and safety features which include:

- **Menu-driven program** that simplifies set-up
- **Ten ranges** of Conductivity measurements-software selectable (*Appendix 2*).
- **Built-in memory backup** to ensure that calibration data and other information are not erased if power supply fails
- **Automatic temperature compensation (ATC)** with Pt100 or Pt 1000
- **Manual temperature compensation** with independent setting for calibration and process temperature
- Temperature coefficient variable between 0.00 to 10.00 % per °C. Separate pure water compensation curve stored in memory. Reference temperature at 25°C.
- 0 to 1999 second **time delay adjustment** on all relays – minimise false alarms
- Separately adjustable **high and low set point hysteresis** (dead bands) prevents chattering of relays around the set points. Selectable **Filter** function stabilises rapid measurement changes
- **Four operating modes:** limit, display monitor , proportional pulse length or proportional pulse frequency control.
- **Large dual display LCD** for easy reading with clear multiple annunciators, alarm status and operational message annunciators
- **Two switching contacts as set-point triggering relays** and an alarm output relay
- Separate **alarm relay** alerts you when set points have exceeded the limits and if the Pt100/Pt1000 wires are broken or disconnected during the ATC function
- **Hold** function freezes output current (**0/4...20mA**) and releases control relays
- **LED indicators** signal control activities to monitor controller status from a distance
- **Protection against electromagnetic interference** - galvanically isolated 0/4 - 20mA output provides safety for data logging and control purposes

1.2 Applications

Use this controller in panel mounted enclosures for applications in water treatment and demineralization, waste water treatment and neutralization processes.

2 ASSEMBLY AND INSTALLATION

2.1 Measurement and Control System

A typical measurement system consists of:

- a Alpha COND 1000 process controller
- a suitable Conductivity electrode with the appropriate Cell constant and integrated temperature sensor Pt 1000 or Pt 100,
- an immersion, flow or process assembly
- a final control element such as pump or valve and
- a chart recorder.

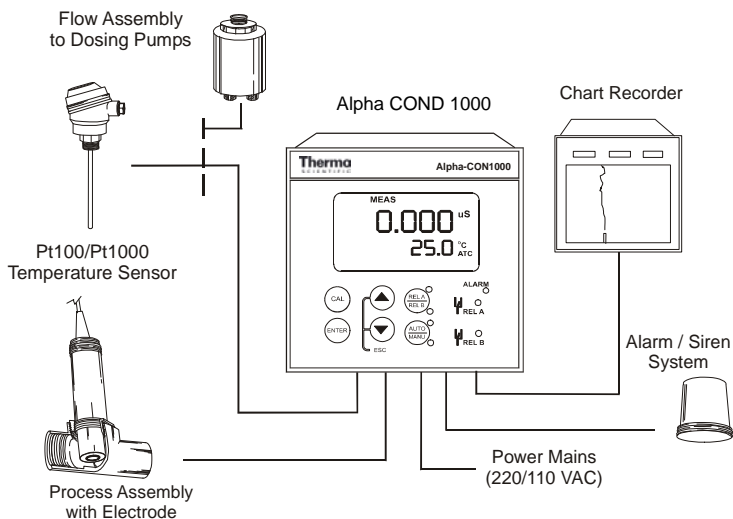

2.2 Unit Dimensions

The field-tested control panel housing is 96 x 96 mm; with protection class IP 54 (front).

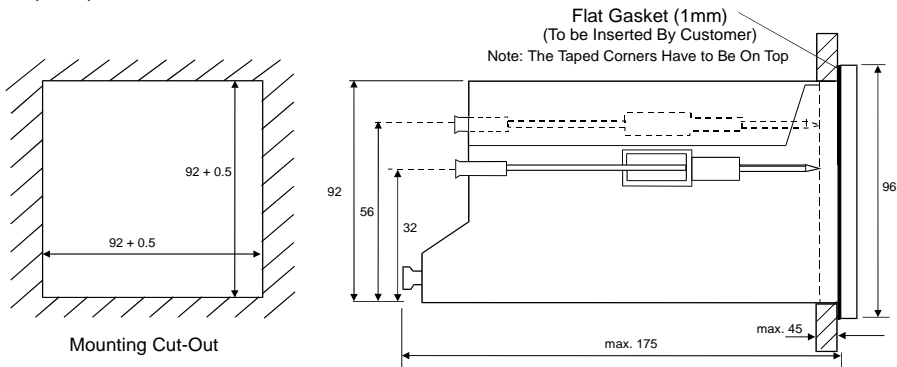

3 ELECTRICAL CONNECTION



ENSURE that the power cable is physically separated from the power supply.

3.1 Connection Diagram

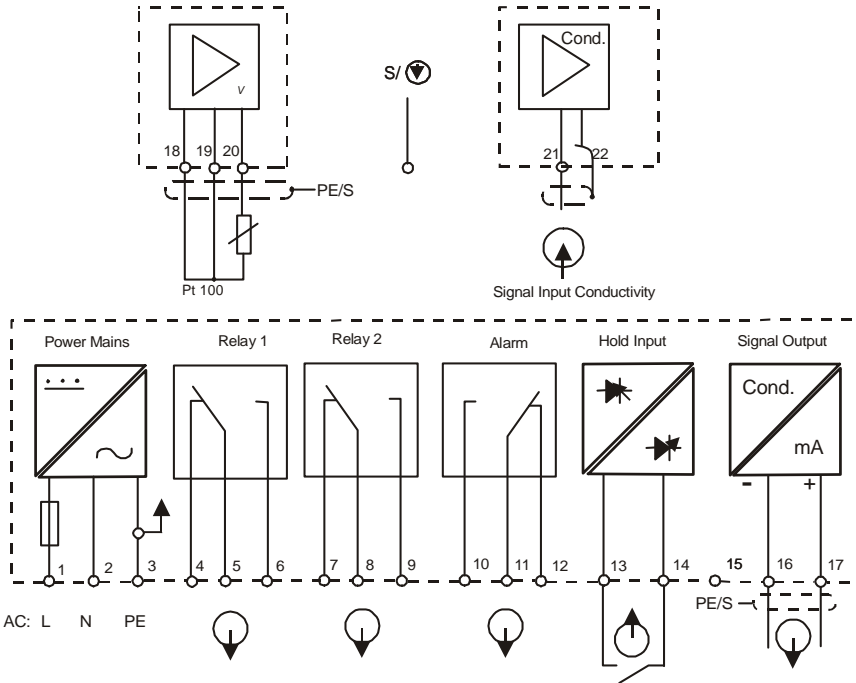

*) indicated contact positions are for currentless or no error conditions

3.2 Back Panel

The back panel consists of two connectors. The first connector is the 17-way PCB edge connector and the other is the 5-way connector.



ENSURE that the power cable is physically separated from the power supply.

Connection for the 17-way screw terminals (from left to right):

- | | |
|---|---------------------------------------|
| 1. AC mains live wire | 10. Alarm relay resting position (NO) |
| 2. AC mains neutral wire | 11. Alarm relay common |
| 3. AC mains protective earth wire | 12. Alarm relay working position (NC) |
| 4. Low set relay resting position (NC) | 13. Hold function switch terminal 1 |
| 5. Low set relay common | 14. Hold function switch terminal 2 |
| 6. Low set relay working position (NO) | 15. No connection |
| 7. High set relay resting position (NC) | 16. 0/4 - 20 mA for -ve connection |
| 8. High set relay common | 17. 0/4 - 20 mA for +ve connection |
| 9. High set relay working position (NO) | |

Connections for the 5-way screw terminals:

- 18. Pt1000/Pt100 lead 1 terminal
- 19. Pt1000/Pt100 sense lead terminal
- 20. Pt1000/Pt100 lead 2 terminal
- 21. Conductivity lead 1
- 22. Conductivity lead 2

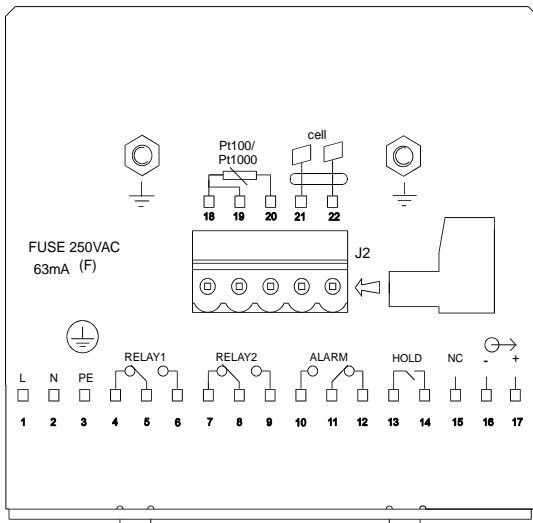

IMPORTANT: The Alarm relay functions as an “Active Low” device i.e. it switches OFF under Alarm condition. Therefore the Alarm display device should be connected to the ‘NC’ contacts of the relay.

4 OVERVIEW

4.1 Keypad and Display

4.1.1 Keypad



- Perform rapid calibration



- Allows entry to Set up mode
- Select individual functions within the function group of Set up mode
- Store input data in the **Set up** mode
- Start calibration in the calibration mode

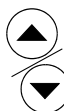

- Select various function groups in the Set up mode.
- Set parameters and numerical values in sub functions of **Set up** mode
If pressed continuously, the setting speed increases
- Control the relays in the **MANUAL** function
- Return to the Measurement mode when both keys are pressed together



- Switch between **AUTO** and **MANUAL** relay operation using a code



- Display limit set-point values for the switch contacts in **AUTO** relay operation mode
- Switch between **RELAY A** and **RELAY B** in **MANUAL** relay operation mode

4.1.2 Display

The LCD display features two numerical displays that show status messages and measured values for easy, quick reference. The display provides short-text information for setting parameters and configuration.

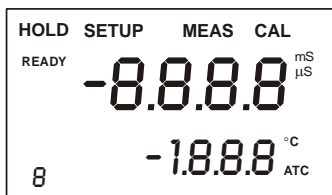

- **HOLD:** Relay position and current output are frozen
- **SETUP:** Set-up mode of function groups
- **MEAS:** Measurement mode
- **CAL:** Calibration mode of Conductivity
- **READY:** Comes on after a successful calibration
- **ATC:** Comes on in the ATC mode. Disappears in the Manual temperature Compensation mode. "ATC" flashes if the temperature probe is faulty in its ATC mode
- **8:** Indicates the measurement range selected. Refer to Appendix 2.



- Display for RELAY A/B. Green LED indicates measured value within limit while RED LED indicates measured value outside limit.



- Alarm display if limit value overshoot or the ATC connection is broken.

4.2 Function Groups

The main function and sub-function groups are organised in a matrix format for configuration and selection of parameters. The main function groups are:

- 1) Temperature Coefficient settings (**tc**). See Section 7.1.
- 2) Temperature Measurement / compensation settings (**SEt °C**). See Section 7.2.
- 3) Control relay 1 configuration (**SP1**). See Section 7.3.
- 4) Control relay 2 configuration (**SP2**). See Section 7.3.
- 5) Control type (**Cntr**). See Section 7.4.
- 6) Current output (**rng**). See Sections 7.5 & 7.6.
- 7) Configuration (**ConF**). See Section 7.7.
- 8) Calibration (**CAL Con**). See Sections 6 & 7.8.

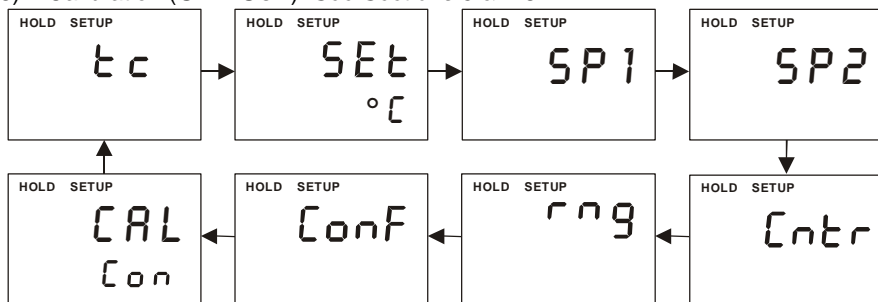

The set-up parameters can be viewed or changed by entering a security code. See Section 5.2 for security code information.

4.2.1 How to view operating parameters without access to change them:

- a) Press the **ENTER** key. The display will prompt the user to enter a security code (S.Cd). Leave the security code at "000" (do not enter a security code).
- b) Press **ENTER** key again. This allows you only to view (not change) any sub-functions' settings.
- c) Press the **▲** or **▼** keys to scroll through the sub-functions.
- d) Press the **ENTER** key at a particular sub-function to view in detail.
- e) Press the **ENTER** key to return to the sub-function menu.
- f) Press the **▲** or **▼** keys simultaneously (as an Escape key) at any time to return to the Measurement mode.

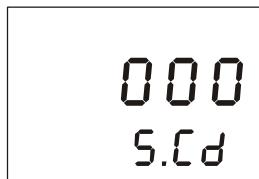

Note: To simplify operations, the controller will not display parameters that are not relevant to a particular sub-function. For example: If the user set the controller for Limit control, it will not display pulse length/frequency settings.

4.3 Control Concept

The main function and sub-function groups are organised in a matrix format as shown below. These functions can be accessed via the front keypad for configuration and selection of parameters.

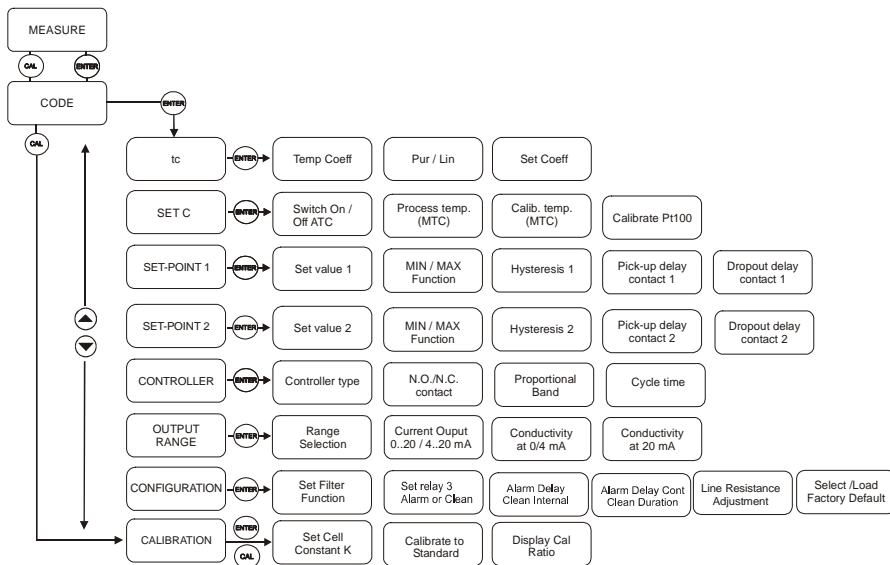

The controller offers two levels of password protection: (1) for direct access to calibration function and (2) for setting or editing specific controller parameters or functions in the SETUP mode to suit individual requirements.

Note: The passwords are not user-defined and have been set by factory. It is very important to keep these passwords strictly confidential to avoid unauthorised tampering of the system at all times.

Note: If the user reads parameters only, the controller automatically reverts to Measurement mode if none of the keys is pressed for 30 seconds.

5 MEASUREMENT

5.1 Display in Measurement mode

When the controller is initially powered on, it automatically enters into the Measurement mode after the large dual LCD displays all segments briefly.

The upper display shows the measured Conductivity value, while the lower display shows the temperature value. Annunciators at the right side of the display indicate whether the controller is set for μS or mS measurement. Similarly annunciators or icons at the top or left side of the display shows the current status of controller, e.g. "HOLD", "SETUP", "MEAS", "CAL", "READY", etc.

5.1.1 Check electrode performance

To read current electrode slope and offset values without changing them:

- 1) Press the **CAL** key followed by the **ENTER** key without adjusting the security code (leave code at "000"). The upper display shows the condition of the probe. The lower display reading shows the temperature reading.

Note: *If security code is changed to a value other than "000", pressing the **ENTER** key will return to the Measurement mode, without displaying electrode information.*

- 2) Press the **ENTER** key a second time to return to Measurement mode.

5.1.2 Checking set points

To read current set point values without changing them:

- Press the **RELAY Selection (Rel A / Rel B)** key. The upper display shows the set point for Relay A; the lower display shows "SP1".
- After two seconds the upper display shows the set-point value for Relay B; the lower display shows "SP2".
- After an additional two seconds, the controller returns to the Measurement mode.

5.2 Security Codes

This controller has two levels of security protection with separate security codes. The first level allows entry into the Calibration mode: security code = 11; the second allows entry into the SETUP mode: security code = 22.

The security codes protect the controller from unauthorised tampering of its current setting. The parameters cannot be changed unless the security code is entered.

5.2.1 How to enter and change parameters in Calibration mode

- 1) Press the **CAL** key. The upper display shows “000” and the lower display shows “C.Cd” to prompt the user to enter the Calibration security code.
- 2) Press the **▲** or **▼** keys to scroll upper display to Calibration security code “11”.
- 3) Press the **ENTER** key. The display shows “CAL CON”.
- 4) Press **ENTER** key again to begin calibration. Refer to Section 6 for full details on calibration.
- 5) Press the **▲** or **▼** keys simultaneously (escape) to return to the Measurement mode.

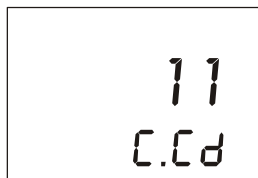

NOTE: To view (not change) the *SETUP* parameters, push the **ENTER** key when the security code reads “000”.

5.2.1.1 Clearing the Calibration security code from the display

The calibration security code automatically resets from “11” to “000” after you return to Measurement mode, so you do not need to clear the security code from the display.

5.2.2 How to enter and change parameters in Advanced Setup mode

- 1) Press the **ENTER** key once. The upper display shows “000” and the lower display shows “S.Cd” to prompt you to enter the Advanced Setup security code.
- 2) Press the **▲** or **▼** keys to scroll the display to Setup security code “22”. **NOTE:** Pressing the **ENTER** key at a value other than “22” causes the controller to revert to the Measurement mode.
- 3) Press the **ENTER** key.
- 4) The upper display reads “tc”.
- 5) You are now in the Advanced Setup mode. See Section 7 for complete instructions. To return to Measurement mode, press the **▲** or **▼** keys simultaneously (escape).

NOTE: If you want to view (not change) set up parameters, push the **ENTER** key when the security code reads “000”.

5.2.2.1 Clearing the Advanced Setup security code from the display

After you have entered the security code and returned to the Measurement mode, the security code "22" still appears on the display whenever you press the **ENTER** key. To conceal the security code, you must manually reset the code. To clear the Advanced Setup security code from the display:

- 1) Press the **ENTER** key in the Measurement mode.
- 2) Set to any security code (not 11 or 22) and complete by pressing **ENTER**.

NOTE: *When you enter the Calibration mode with code "11" or Advanced Setup mode with security code "22", the unit automatically enters into the HOLD mode until you return back to Measurement mode. The HOLD annunciator is displayed at the upper left of the display. While on HOLD, the current output is frozen and set point relays are deactivated.*

6 CALIBRATION MODE

You can reach the Calibration mode directly from the Measurement mode by pressing the CAL key and entering the Calibration security code. You can also reach the Calibration mode from the Advanced Setup mode.

6.1 Conductivity Calibration

Calibration is always carried out in the specific range selected. The Conductivity Controller allows a one-point calibration.

- 1) Enter Calibration mode. While in the Measurement mode, push the CAL key and scroll to Calibration code "11". Push the **ENTER** key again. The upper display reads "CAL" and the lower display shows "Con".
- 2) Press the **ENTER** key. The controller displays its last set Cell Constant (k) of the cell as a percentage of the theoretical value. Using the ▲ and ▼ keys, the value can be set to anywhere from 80 to 120% (e.g. real cell constant is 0.98 with nominal =1, enter 98%). Press the **ENTER** key once again to carry out calibration.
- 3) Immerse the Conductivity cell in a suitable standard solution, whose value is within the measurement range selected in the controller. Agitate the Cell in the solution to remove any trapped air-bubbles.

Note: The calibration standard should have a value that is between 20% to 100% of the range selected. For example, if the range in the controller is selected to be 2000 μS (range 6), then the calibration standard value should be 400 μS to 2000 μS .

- 4) Once the reading has stabilized, use the ▲ or ▼ keys to adjust the measured value to that of the standard solution. Press the **ENTER** key to accept the value and the controller displays the revised condition of the probe. The lower display shows the factor "Fct" while the upper display shows the ratio of ideal to adjusted calibration value.

Note: The acceptable calibration window is $\pm 40\%$ of the displayed (default) value. If the display is 1000 μS , the values to which it can be adjusted is 600 to 1400 μS . If there is calibration error, the controller displays "ERR" annunciator. To re-calibrate repeat step 3. To exit from calibration, push both ▲ and ▼ keys (escape) to resume to Measurement mode.

- 5) Press the **ENTER** key. If you entered the calibration mode using the CAL key, the controller will return to the Measurement mode. If you entered the calibration mode from the Advanced Set-up mode, the controller will return to the sub-function menu.

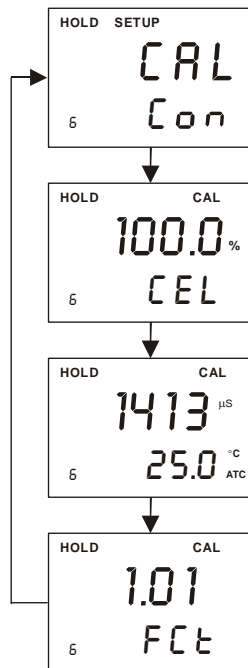

Note: *When calibrating with manual temperature compensation, the controller automatically changes from the preset process temperature to the calibration temperature. After leaving the Calibration mode, the controller switches back to process temperature (for setting the calibration temperature and the process temperature, see section 7.2.1).*

7 ADVANCED SET-UP MODE

7.1 Temperature Coefficient sub-function

This sub-function allows you to select the correct temperature coefficient for optimum operations. For applications in the pure water or ultra-pure water industries, simply select the “Pur” temperature coefficient option. For all other applications, select “Lin” temperature coefficient. The controller allows further input of temperature coefficient values, independently for the process and for the calibrating solutions. Default is at 2.10 %.

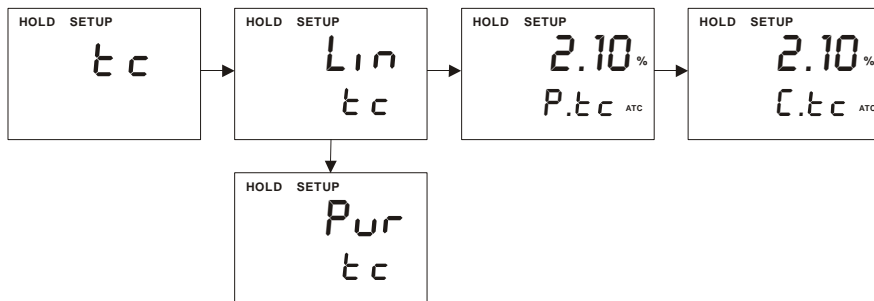

7.1.1 Selecting Pure-water or Linear Temperature Coefficient

- 1) Enter Advanced set-up mode. Push the **ENTER** key and use **▲** or **▼** keys to scroll to Advanced Set-up security code “22”.
- 2) Push the **ENTER** key. Controller displays “tc”.
- 3) Push **ENTER** key again and use **▲** or **▼** keys to select between “Pur” and “Lin” temperature coefficients.
- 4) If “Pur” tC is be selected, press the **ENTER** key and controller goes back to “tc”. If “Lin” tC is selected, press the **ENTER** key and proceed to step 5.
- 5) The upper display shows “2.10%”, while the lower display show “P.tc”. This option allows you to input the Process Temperature coefficient, from 0 to 10%. Default is 2.10%. Use the **▲** or **▼** keys to enter the required temperature coefficient value.
- 6) Press the **ENTER** key. Next, enter the temperature coefficient of the calibration solution (0 to 10%). Default is 2.10%.
- 7) Press the **▲** or **▼** keys to input the desired calibration solution temperature coefficient.
- 8) Press the **ENTER** key to accept the value.
- 9) Continue with additional Advance setup procedures or return to Measurement mode by pressing the **▲** and **▼** keys (escape) simultaneously.

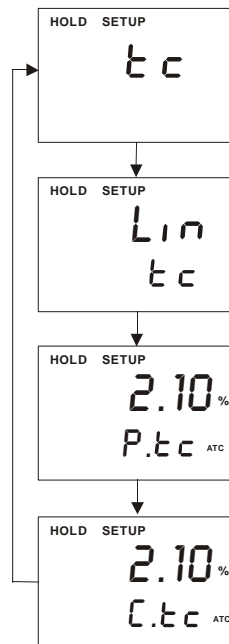

7.2 Temperature Calibration (ATC mode only)

- 1) Enter Advanced Set-up mode. Push the **ENTER** key and (use **▲** or **▼** keys to) scroll to Advanced Set-up security code "22". Push the **ENTER** key again.
- 2) Press the **▲** or **▼** keys to scroll until the display shows "SEt °C". Push **ENTER** key.
- 3) Press the **▲** or **▼** keys to select "on ATC". Press **ENTER** key.
- 4) The upper display indicates the current temperature offset. The current measured temperature is shown in the lower display.
- 5) Compare the current measured temperature on the controller display to a thermometer known to be accurate. Note down the correct temperature.
- 6) Press the **▲** or **▼** keys to scroll the lower display to match the correct value. The upper display will now show the offset value. You can offset temperature up to ± 5 °C.
- 7) Press the **ENTER** key to confirm your selection.
- 8) Continue with additional Advanced Set-up procedures, or return to the Measurement mode by pressing the **▲** and **▼** keys (escape) simultaneously).

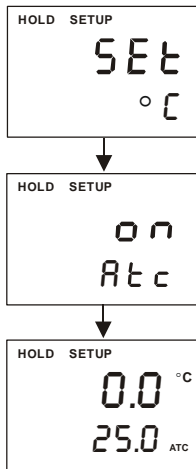

7.2.1 Setting Manual Temperature Compensation

NOTE: This parameter is blanked out when the controller is set for ATC operation.

For manual temperature compensation, you can set two different temperatures: Process and Calibration. This allows calibration at a temperature other than your process temperature. Example: setting a calibration temperature of 25 °C lets you calibrate using standard buffer solutions at 25 °C, even if your process temperature is at different temperature.

- 1) Enter Advanced Set-up mode. Push the **ENTER** key and (use **▲** or **▼** keys to) scroll to Advanced Set-up security code "22". Push the **ENTER** key again.
- 2) Press the **▲** or **▼** keys to scroll until the display shows "SEt °C". Push **ENTER** key.
- 3) Press the **▲** or **▼** keys to select "oFF ATC". Press **ENTER** key.
- 4) The upper display shows the current process temperature and the lower display shows "P. °C" to indicate process temperature.
- 5) Press the **▲** or **▼** keys to adjust the process temperature value. You can adjust the value from -9.9 to 125 °C.

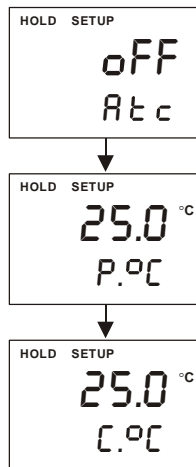

- 6) After you set the process temperature value, press the **ENTER** key. The upper display shows the current calibration temperature and the lower display shows "C.°C" to indicate calibration temperature.
- 7) Press the **▲** or **▼** keys to adjust the calibration temperature value. You can adjust the value from -9.9 to 125 °C.
- 8) Press **ENTER** key to confirm your selection.
- 9) Continue with additional Additional Set-up procedures, or return to Measurement mode by pressing the **▲** and **▼** keys (escape) simultaneously).

7.3 Control Relay A/Control Relay B (SP1/SP2) sub-function

The SP1 option sets the operating parameters for Relay A; and SP2 for relay B. Since these groups have the same set-up parameters, they are described together.

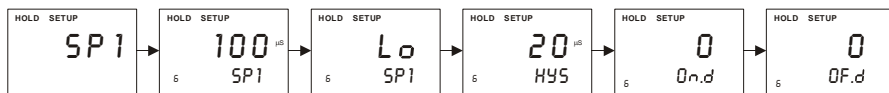

7.3.1 Entering the Set point 1 (or Set point 2) sub-function

The alpha CON 1000 controller/transmitter can operate in either one of the 10 different conductivity ranges (see Section 12.2 – *Appendix 2: Measurement Ranges Available in the Controller*. Refer to Section 7.5.1 for *Selecting the Measuring Range sub-function*.

- 1) Enter Advanced Set-up mode. Push the **ENTER** key and (use **▲** or **▼** keys to) scroll to Advanced Set-up security code "22". Push the **ENTER** key again.
- 2) Press the **▲** or **▼** keys to scroll until the upper display shows SP1 (or SP2).

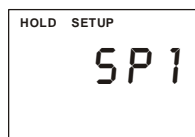

7.3.2 Selecting the set point values

This lets you choose the value that will cause your controller to activate (Default: SP1 = 100 μS; SP2 = 1900 μS).

- 1) Press the **ENTER** key until upper display shows the current set point value and the lower display shows SP1 (or SP2).
- 2) Press the **▲** or **▼** keys to select your value for Set point 1 (or Set point 2). Your controller will activate at the value you select.
- 3) Press the **ENTER** key to confirm your selection.
- 4) Proceed to 7.3.3, or return to Measurement mode by pressing the **▲** and **▼** keys simultaneously (escape).

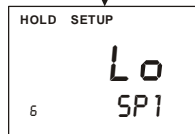

7.3.3 Choosing High or Low set points

Select a low set point to activate controller when the conductivity value undershoots the low set point; select a high set point to activate controller when the value overshoots the high set point. Using both SP1 and SP2, you can select lo/lo, lo/hi, hi/lo, or hi/hi set points (Default: SP1 = Lo; SP2 = Lo).

- 1) Follow directions in 7.3.1 to enter Control Relay mode.
- 2) Press the **ENTER** key. Scroll with the ▲ or ▼ keys until the upper display shows Lo or Hi (for low or high set point) and the lower display shows SP1 (or SP2).
- 3) Press the ▲ or ▼ keys to select low (lo) or high (hi) set point for SP1 (or SP2).
- 4) Press the **ENTER** key to confirm your selection.
- 5) Proceed to 7.3.4, or return Measurement mode by pressing the ▲ and ▼ keys simultaneously (escape).

7.3.4 Selecting a hysteresis (dead band) value

Hysteresis prevents rapid contact switching if your value is fluctuating near the set point. It does this by overshooting the set point value to a specified hysteresis value

Example: You have set your set point 1 (Lo) at 100.0 μS and your hysteresis limit value is at 20 μS . If your measured value undershoots the low set point of 100.0 μS , the controller's relay activates, which in turn activates an external device such as a pump or valve. The actions of the external device will cause the value to rise above 100.0 μS . When the value has increased to 120.0 μS , the relay, and hence the pump will switch off.

Default hysteresis value in the full scale conductivity range of 2,000 μS (see Appendix 2) is 20 μS . You can set the hysteresis value from 0 to 10% of the full scale conductivity range.

- 1) Follow directions in 7.3.1 to enter Control Relay mode.
- 2) Press the **ENTER** key. Scroll with the ▲ or ▼ keys until the upper display shows the hysteresis (dead band) value and the lower display shows "HYS".
- 3) Press the ▲ or ▼ keys to enter your hysteresis value for Set point 1 (or Set point 2). Your controller will activate at the value you select. **Note:** All settings for SP1 and SP2 are completely independent of each other.
- 4) Press the **ENTER** key to confirm your selection.
- 5) Proceed to 7.3.5, or return to Measurement mode by pressing the ▲ and ▼ keys simultaneously (escape).

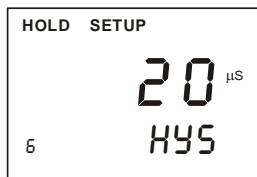

NOTE: Please refer to Appendix 3 for a graphical representation of the Hysteresis.

7.3.5 Setting an on-delay time lag

You can set a time delay for each relay, which stops the relay from switching on the moment the set point is exceeded. This controller lets you set a 0 to 1999 seconds time delay before the relay activates.

- 1) Follow directions in 7.3.1 to enter Control Relay mode.
- 2) Press the **ENTER** key. Scroll with the ▲ and ▼ keys until the upper display shows “0” time and the lower display shows “On.d”.
- 3) Press the ▲ or ▼ keys to enter on-delay time for Set point 1 (Set point 2). The controller will delay activation for the number of seconds (0 to 1999) you select.
- 4) Press the **ENTER** key to confirm your selection.
- 5) Proceed to 7.3.6, or return to Measurement mode by pressing the ▲ and ▼ keys simultaneously (escape).

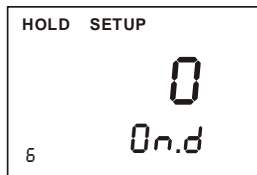

7.3.6 Setting an off-delay time lag

You can set a time delay for each relay, which stops the relay from switching off the moment the value reached the set point and hysteresis. This controller lets you set a 0 to 1999 seconds time delay before your relay deactivates.

- 1) Follow directions in 7.3.1 to enter Control Relay mode.
- 2) Press the **ENTER** key. Scroll with the ▲ or ▼ keys until the upper display shows “0” time and the lower display shows “OF.d”.
- 3) Press the ▲ or ▼ keys to enter on-delay time for Set point 1 (Set point 2). Your controller will delay activation for the number of seconds (0 to 1999) you select.
- 4) Press the **ENTER** key to confirm your selection.
- 5) Continue with Advanced Set-up mode procedures, or return to Measurement mode by pressing the ▲ and ▼ keys simultaneously (escape).

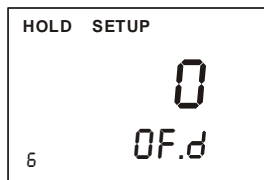

7.4 Controller (Cntr) sub-function

You can set the controller's parameters in this sub-function.

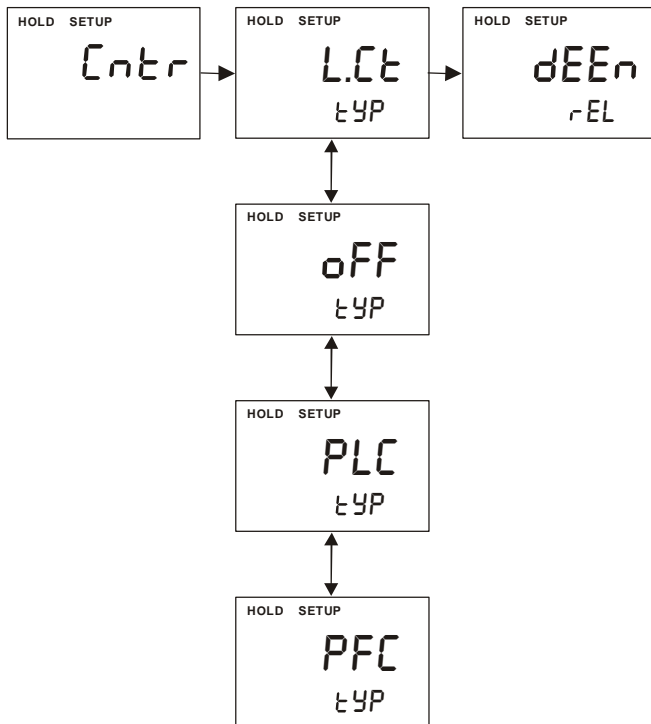

7.4.1 Entering the Controller sub-function

- 1) Enter Advanced Set-up mode. Push the **ENTER** key and scroll to Advanced set-up security code "22". Push the **ENTER** key again.
- 2) Press the ▲ or ▼ keys to scroll until the upper display shows "Cntr".

7.4.2 Choosing the controller type (limit or proportional)

This mode lets you choose your controller type: limit control, pulse length proportional control, pulse frequency proportional control, or control off.

- Use limit control with pumps or valves for fast response.
 - Use pulse frequency proportional control to operate your pumps smoothly
 - Use pulse length proportional control for precise control of proportional valves.
 - Use control off to operate controller as a monitor only or to prevent relays from switching.
- 1) Follow directions in 7.4.1 to enter Controller mode.
 - 2) Press the **ENTER** key. The upper display shows the current controller type and the lower display shows “tyP”.
 - 3) Press the **▲** or **▼** keys to select your controller type.
 - L.Ct = limit value pickup (on/off control).
 - oFF = controller off.
 - PLC= pulse length control
 - PFC= pulse frequency control
 - 4) Press the **ENTER** key to confirm your selection.
 - 5) Proceed to 7.4.3, or return to Measurement mode by pressing the **▲** and **▼** keys simultaneously (escape).

7.4.3 Choosing Break/Make Contact Relay Type

Note: If the controller type “oFF” is set, the parameters listed in 7.4.3, 7.4.4, and 7.4.5 are blanked out.

This mode lets you determine the relay-state under Non-Alarm condition – dEEN (de-energised) or EN (energised).

- 1) Follow directions in 7.4.1 to enter Controller mode.
- 2) Press the **ENTER** key. Scroll until the lower display shows “rEL” and the upper display shows the current selection (de-energised = dEEN or energised = EN).
- 3) Press the **▲** or **▼** keys to choose de-energised or energised relay state.
- 4) Press the **ENTER** key to confirm your selection.
- 5) Continue with Advanced Set-up mode procedures, or return to Measurement mode by pressing the **▲** and **▼** keys simultaneously (escape).

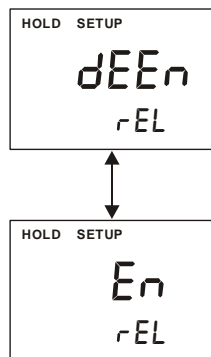

7.4.4 Selecting Proportional Range Value, Xp

Note: If the controller type “oFF” is set, the parameters listed in 7.4.3, 7.4.4, and 7.4.5 are blanked out.

This mode lets you set a band as a percentage of its full scale value. You can select this range from 10 to 200%, and the lower display shows “PrP”.

- 1) Follow directions in 7.4.1 to enter Controller mode.
- 2) Press the **ENTER** key. Follow directions in 7.4.2 and select either “PLC” (pulse length control) or “PFC” (pulse frequency control). Press **ENTER** key.
- 3) Press the **ENTER** key until the upper display shows the proportional range (a number from 10 to 200%), and the lower display shows “PrP”.
- 4) Press the **▲** or **▼** keys to choose the proportional range value Xp.
- 5) Press the **ENTER** key to confirm your selection.
- 6) Proceed to 7.4.5, or return to Measurement mode by pressing the **▲** and **▼** keys simultaneously (escape).

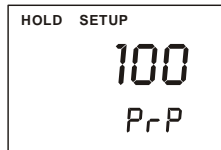

7.4.5 Maximum Pulse Length (tPL) or Maximum Frequency (FPF)

Note: If the controller type “oFF” is set, the parameters listed in 7.4.3, 7.4.4, and 7.4.5 are blanked out.

This mode lets you set the maximum pulse length or the maximum frequency at which the relay will operate.

- 1) Follow directions in 7.4.1 to enter Controller mode.
- 2) Press the **ENTER** key. Scroll until the lower display shows “t.PL” or “F.PF”.
 - a. In PLC (pulse length) mode: The lower display shows “t.PL” to indicate pulse length. The upper display shows your current pulse length. You can select any value from 0.5 to 20 seconds.
 - b. In PFC (pulse frequency) mode: The lower display shows “F.PF” to indicate pulse frequency. The upper display shows your current maximum pulse rate. You can select any value from 60 to 120 pulses per minute. When the measured value exceeds the Proportional Band in 7.4.4, the controller will pulse the relay at this rate.
- 3) Press the **▲** or **▼** key to choose the period duration or maximum frequency, depending on your mode.
- 4) Press the **ENTER** key to confirm your selection and to return to Advanced Set-up mode, or return to Measurement mode by pressing the **▲** and **▼** keys simultaneously (escape).

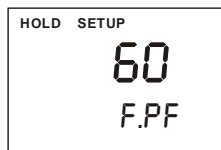
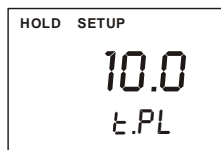

Note: The alarm contact is always of the fail-safe type. In the event of power failure the alarm is triggered.

7.5 Measurement Range sub-function

In this sub-function, the appropriate range is selected with the appropriate cell constant.

7.5.1 Selecting the Measuring Range sub-function

- 1) Enter Advanced Set-up mode. Push the **ENTER** key and scroll to Advanced Set-up security code "22". Push the **ENTER** key again.
- 2) Press the **▲** or **▼** keys to scroll until the upper display shows "rng".
- 3) Press the **ENTER** key. The upper display shows the maximum measurement range, while the lower display shows the Cell constant. In the lower left-corner of the LCD, the number corresponding to the respective range is displayed.
- 4) Press the **▲** or **▼** keys to select the correct range. (Please refer to Section 12.2 Appendix 2 for the full list of measurement ranges).
- 5) Proceed to 7.6 to set current output or return to Measurement mode by pressing the **▲** and **▼** keys simultaneously (escape).

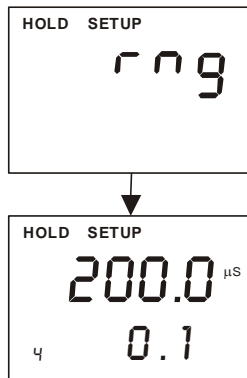

7.6 Current Output (rng) sub-function

This sub-function lets you set the transmitter current output range of this unit. The difference between the upper and lower range has to be a minimum of 20% of Full Scale, anywhere on the scale.

7.6.1 Entering current output sub-function

- 1) Enter Advanced Set-up mode. Push the **ENTER** key and scroll to Advanced Set-up security code "22". Push the **ENTER** key again.
- 2) Press the **▲** or **▼** keys to scroll until the upper display shows "rng". Press **ENTER**.
- 3) Measurement range selection. Please refer to 7.5. Press **ENTER** to proceed to current output sub-function (7.6.2)

7.6.2 Choosing the output type

This parameter lets you choose between 0-20 mA or 4-20 mA output.

- 1) Follow directions in 7.6.1 to enter Current Output mode.
- 2) Press the **ENTER** key. Scroll with the **▲** or **▼** keys until the upper display shows the output type (0-20 or 4-20), and the lower display shows "out".
- 3) Press the **▲** or **▼** keys to select your output type: 0-20 or 4-20 mA.
- 4) Press the **ENTER** key to confirm your selection.
- 5) Proceed to 7.6.3, or return to Measurement mode by pressing the **▲** and **▼** keys simultaneously (escape).

7.6.3 Selecting Conductivity value at 0(4)mA

This parameter lets you choose the conductivity value at which the transmitter output will be 0(4) mA.

- 1) Follow directions in 7.6.1 to enter Current Output mode.
- 2) Press the **ENTER** key. Scroll with the **▲** or **▼** keys until the upper display shows a conductivity value and the lower display shows "r.0(4)".
- 3) Press the **▲** or **▼** keys to select the required conductivity value to be equivalent to 0(4) mA (0.00 to 80.0 % F.S.; Default is 0% F.S.).
- 4) Press the **ENTER** key to confirm your selection.
- 5) Press the **ENTER** key to return to Advanced Set-up mode, or return to Measurement mode by pressing the **▲** and **▼** keys simultaneously (escape).

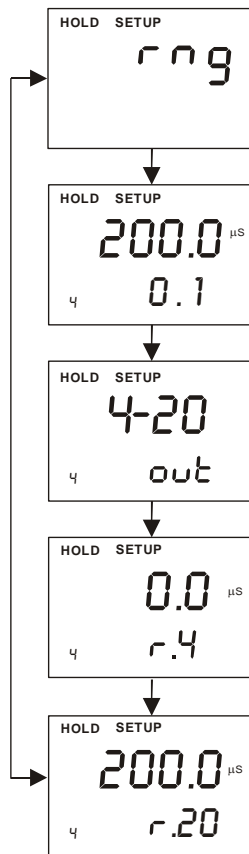

7.6.4 Selecting Conductivity value at 20mA

This parameter lets you choose the conductivity value at which the transmitter output will be 20mA.

- 1) Follow directions in 7.6.1 to enter Current Output mode.
- 2) Press the **ENTER** key. Scroll with the **▲** or **▼** keys until the upper display shows a conductivity value and the lower display shows "r.20".
- 3) Press the **▲** or **▼** keys to select the required conductivity value to be equivalent to 20 mA (20.0 to 100.0% F.S.; Default is 100% F.S.).
- 4) Press the **ENTER** key to confirm your selection.
- 5) Press the **ENTER** key to return to Advanced Set-up mode, or return to Measurement mode by pressing the **▲** and **▼** keys simultaneously (escape).

7.7 Configuration (ConF) sub-function

This group of parameters lets you configure the controller to suit your requirements.

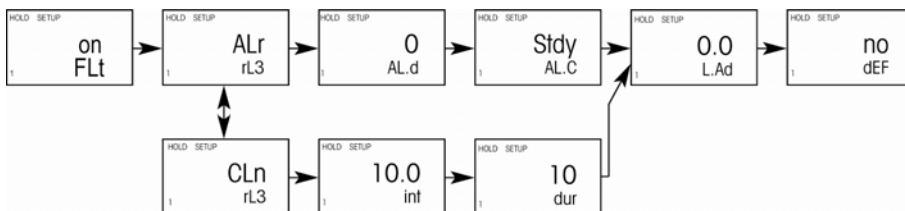

7.7.1 Entering the Configuration sub-function

- 1) Enter Advanced Set-up mode. Push the **ENTER** key and scroll to Advanced Set-up security code "22". Push the **ENTER** key again.
- 2) Press the **▲** or **▼** keys to scroll until the upper display shows "ConF". Press **ENTER** key to enter configuration sub-function.

7.7.2 Selecting Filter Function and the Alarm or Wash Function

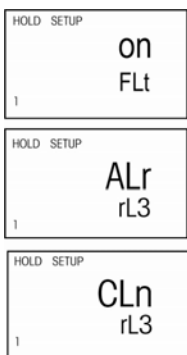

In this configuration sub-function, you have the 'Filter' selection which lets you filter rapid measurement changes and stabilising the measurement. This configuration sub-function also allows you to use the Alarm relay as Wash or Clean contact. The Wash (Clean) contact is used in combination with automatic cleaning systems. During the wash cycle, the analog output is set on hold.

- 1) In **Filter** selection mode, use the arrow keys to choose filter "on" or "off".
- 2) **Press the ENTER key** to confirm. Display will now show "ALr" or "CLn".
- 3) Press the **▲** or **▼** key to choose "ALr" (Alarm) or "CLn" (Clean) function.

- 4) Press the **ENTER** key to confirm your selection.
- 5) Proceed to 7.7.3, or return to Measurement mode by pressing the **▲** and **▼** keys simultaneously (escape).

Note: The factory default setting for the **Filter** selection is "on".

7.7.3 Selecting the alarm time lag

This parameter group lets you select a period of time before the alarm activates when your set point has been overshoot. You can select from 0 to 1999 seconds.

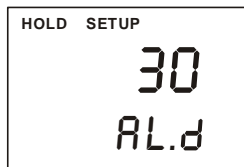

- 1) Follow directions in 7.7.1 to enter Configuration mode.
- 2) Press the **ENTER** key. Scroll with the **▲** or **▼** keys until the upper display shows a numerical value (in seconds) and the lower display shows "AL.d".
- 3) Press the **▲** or **▼** keys to select how long of an alarm delay (0 to 1999 seconds) you want.
- 4) Press the **ENTER** key to confirm your selection.
- 5) Proceed to 7.7.4, or return to Measurement mode by pressing the **▲** and **▼** keys simultaneously (escape).

7.7.4 Selecting steady or pulse contact for the alarm relay

This parameter group lets you select whether the alarm contact will operate as a steady contact or a fleeting (single pulse) contact. Pulse contact closing time is 250 millisecond.

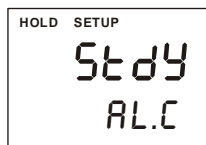

- 1) Follow directions in 7.7.1 to enter Configuration mode.
- 2) Press the **ENTER** key. Scroll with the **▲** or **▼** keys until the upper display shows "Stdy" or "FLEt" and lower display shows "AL.C".
 - AL.C = alarm contact
 - StdY = steady contact
 - FLEt = fleeting (single pulse) contact

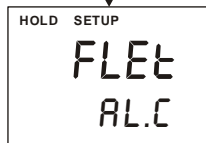

- 3) Press the **▲** or **▼** keys to select steady or pulse contact.
- 4) Press the **ENTER** key to confirm your selection.
- 5) Proceed to 7.7.5, or return to Measurement mode by pressing the **▲** and **▼** keys simultaneously (escape).

7.7.5 Wash contact (if the relay 3 is set to Wash)

- 1) Follow directions in 7.7.1 to enter Configuration mode.
- 2) Press the **ENTER** key until display shows "ALr" or "CLn". Choose "CLn" by pressing **▲** or **▼** key. Press the **ENTER** key.
- 3) Press the **▲** or **▼** key to select the wash cycle (interval 0.1 to 199.9 hours) and press the **ENTER** key to confirm.
- 4) Press the **▲** or **▼** key to select the wash duration (1 to 1999 seconds) and press the **ENTER** key to confirm.
- 5) Proceed to 7.7.6, or return to Measurement mode by pressing the **▲** and **▼** keys simultaneously (escape).

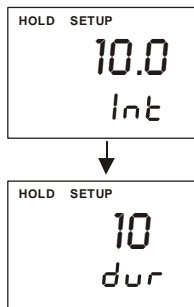

7.7.6 Input Line Resistance Adjust

This function compensates for the line resistance of the cable to its cell.

- 1) Follow directions in 7.7.1 to enter Configuration mode.
- 2) Press the **ENTER** key. Scroll with the **▲** or **▼** keys until the upper display shows "0.0" and lower display shows "L.Ad".
 - L.Ad = line adjuster resistance (0.0 to 100.0)
- 3) Press the **▲** or **▼** keys to input the value.
- 4) Press the **ENTER** key to confirm your selection.
- 5) Proceed to 7.7.7, or return to Measurement mode by pressing the **▲** and **▼** keys simultaneously (escape).

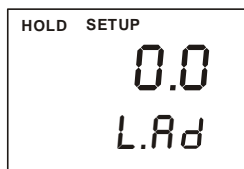

7.7.7 Reverting to factory default settings

Use this parameter to reset all settings to factory default. Changing from "no" to "YES" and pressing the **ENTER** key resets all settings to factory default.

WARNING: If you select yes, all the settings you have made will be overwritten as a result!

- 1) Follow directions in 7.7.1 to enter Configuration mode.
- 2) Press the **ENTER** key. Scroll with the **▲** or **▼** keys until the upper display shows "no" or "YES", and the lower display shows "deF" (default).
- 3) Press the **▲** or **▼** keys to select no or yes. Selecting "YES" and pressing the **ENTER** key will overwrite all setting you have made and automatically return you to Measurement mode.
- 4) Press the **ENTER** key to confirm your selection and to return to Advanced Setup mode, or return to Measurement mode by pressing the **▲** and **▼** keys simultaneously (escape).

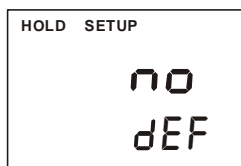

7.8 Calibration (CAL) sub-function

The calibration procedure in Advanced Set-up mode is identical to the procedure in the Calibration mode. The only difference is that the controller will revert back to Set-up mode (instead of Measurement mode) after calibration is completed.

7.8.1 Entering Calibration mode from Advanced Set-up mode

- 1) Enter Advanced Set-up mode. Push the **ENTER** key and scroll to Advanced Set-up security code "22". Push the **ENTER** key again.
- 2) Press the **▲** or **▼** keys to scroll until the upper display shows "CAL".
- 3) See section 6 for complete calibration procedures.

8 AUTO/MANUAL MODE

Regardless of the mode, you can control devices connected to Relay A or Relay B from the front panel of this controller. In Automatic mode, the controller's set point values activate the relays. In Manual mode, you have manual control of the relays so you can prime the pump or check pump status without operating the entire system.

8.1 Auto mode (mode after switch-on)

In this mode, the controller set-point values activate the relays. To view the set-point values:

- 1) Press the **RELAY SELECTION (Rel A/Rel B)** key. The upper display shows your set-point value for Relay A; the lower display shows "SP1".
- 2) After two seconds the upper display shows your set-point value for Relay B; the lower display shows "SP2".
- 3) After an additional two seconds the controller will return to Measurement mode.

8.2 Manual mode

In this mode, you can manually turn on and off the control devices connected to Relay A or Relay B or both.

- 1) Press the **RELAY CONTROL (auto/manu)** key. The upper display shows "000"; the lower display shows "S.Cd" to prompt you to enter the Advanced Set-up code.
- 2) Press the ▲ or ▼ keys to scroll the upper display until it reads "22".
- 3) Press the **ENTER** key. The manual indicator by the RELAY CONTROL key lights up.

Note: Pressing **ENTER** key at a value other than "22" will cause the controller to revert to Measurement mode, and the relays will remain in automatic mode.

- 4) Press the **RELAY SELECTION** key to select either Relay A or Relay B. The LED next to the currently selected relay (A or B) will light.

The manual control options are now available.

- If you selected **Limit control**: The upper display reads the current measured value. The lower display shows "off" or "on" depending on the relay status of the currently selected relay.
- 5) Press the ▲ or ▼ keys to change the Relay on/off status. The LED indicators at the right of the controller will also change between Red and Green to indicate Relay status.

Note: If you wish to manually change the status of both relays, press the **RELAY SELECTION** key at this point and repeat step 5 for the second relay. This first relay will remain under manual control while you are setting the second relay.

- 6) Press the **RELAY CONTROL** key to return to Measurement mode. The relays are now back under automatic control.

9 TECHNICAL SPECIFICATIONS

Conductivity Range	Resolution	Default Cell Constant, K	Optional Cell, K
0.000 to 1.999 $\mu\text{S}/\text{cm}$	0.001 $\mu\text{S}/\text{cm}$	0.01	-
0.00 to 19.99 $\mu\text{S}/\text{cm}$	0.01 $\mu\text{S}/\text{cm}$	0.01	0.1
0.0 to 199.9 $\mu\text{S}/\text{cm}$	0.1 $\mu\text{S}/\text{cm}$	0.1	1.0
0 to 1999 $\mu\text{S}/\text{cm}$	1 $\mu\text{S}/\text{cm}$	1.0	-
0 to 5000 $\mu\text{S}/\text{cm}$	5 $\mu\text{S}/\text{cm}$	1.0	-
0.00 to 19.99 mS/cm	0.01 mS/cm	1.0	-
0.0 to 199.9 mS/cm	0.1 mS/cm	10.0	1.0

Temperature	0-50 °C (Display: -9.9 to 125 °C)
<i>Resolution</i>	0.1 °C
<i>Relative Accuracy</i>	$\pm 0.5\%$
Sensor	Pt 1000/Pt 100
Temperature Compensation	Auto / manual (reference at 25.0 °C)

Set-point and Controller Functions

Controller characteristics	Limit / proportional (pulse or frequency) controller
Pickup / Dropout delay	0 to 1999 sec.
Switching Conductivity hysteresis	0 to 10% of Full Scale
Contact outputs, controller	2 potential-free change-over contacts
Switching voltage	max. 250 VAC
Switching current	max. 3A
Switching power	max. 600 VA

Alarm Functions

Function (switchable)	Latching / pulse
Pickup delay	0 to 1999 sec.
Switching voltage	max. 250 VAC
Switching current	max. 3A
Switching power	max. 600 VA

Electrical Data and Connections

Power Requirements	110 / 220 VAC (jumper selectable)
Frequency	48 to 62 Hz
Signal Output	0/4 to 20 mA, galvanically isolated
Signal Output Load	max. 600 Ω
Connection terminal	Terminal blocks 5-pole / 17-pole, removable
Mains fuse / fine wire fuse	slow-blow 250 V / 100 mA

EMC Specifications

Emissions	According to EN 50081-1
Susceptibility	According to EN 50082-1

Environmental Conditions

Ambient temp. operating range	0 to 50 °C
Relative humidity	10 to 95%, non-condensing

Mechanical Specifications

Dimensions (control panel housing - L x H x W)	175 x 96 x 96 mm
Weights (control panel housing)	max. 0.7 kg
Material	ABS with polycarbonate (front housing)
Insulation (Front / Housing)	IP 54 / IP 40

10 ACCESSORIES

Assembly Accessories

Product Description	Code no.
Conductivity Cell, up to 20 μ S; Cell constant, K=0.01 with integrated Pt 100, Material SS316 and 25ft cable (open-ended)	EC-CS10-0-01S
Conductivity Cell, up to 20 μ S; Cell constant, K=0.01 with integrated Pt 100, Material Titanium and 25ft cable (open-ended)	EC-CS10-0-01T
Conductivity Cell, 0.1 - 200 μ S; Cell constant, K=0.1 with integrated Pt 100, Material SS316 and 25ft cable (open-ended)	EC-CS10-0-1S
Conductivity Cell, up to 200 mS; Cell constant, K=1.0 with integrated Pt 100, Material SS316 and 25ft cable (open-ended)	EC-CS10-1-0S

Note: Above Conductivity Cells can withstand a pressure of up to 6 bar. Please ask your authorised distributor or dealer for the prices.

11 GENERAL INFORMATION

11.1 Warranty

Thermo Scientific warrants this product to be free from significant deviations in material and workmanship for a period of one year from the date of purchase. If repair is necessary and has not been the result of abuse or misuse within the warranty period, please return by freight pre-paid and amendment will be made without any charge. Our Customer Service Dept. will determine if product problem is due to deviations or customer abuse. Out of warranty products will be repaired on a charge basis.

11.2 Packaging

The instrument is packaged in a corrugated box with a warranty card, instruction manual and the following accessories:

- 17-way and 5-way (right-angled) terminal block [1 unit each]
- side threaded rod with catch [2 units]
- receptacle cable lug [1 unit]
- rubber gasket [1 unit]

11.3 Return of Goods

Authorisation must be obtained from our Customer Service Dept. to issue a RMA (Return of Material Authorisation) number before returning items for any reason. When applying for authorisation, please include data requiring the reason of return. Items must be carefully packed to prevent damage in shipment and insured against possible damage or loss. Thermo Scientific will not be responsible for any damage resulting from careless or insufficient packing.

Warning: Shipping damage as a result of inadequate packaging is the user/distributor's responsibility, whoever applicable. Please follow the guidelines below before shipment.

11.4 ***Guidelines for Returning Unit for Repair***

Use the original packaging material, if possible when shipping the unit for repair. Otherwise wrap it with bubble pack and use a corrugated box for better protection. Include a brief description of any faults suspected for the convenience of Customer Service Dept., if possible.

12 APPENDICES



ENSURE that the power cable is physically separated from the power supply.

12.1 ***Appendix 1 – Jumper Positions***

Jumper Positions - Internal to the controller

JP 1	Selects the input voltage 220 VAC.
JP 2	Selects the input voltage 110 VAC.
JP 6	Selects the temperature sensor for Pt1000/Pt100
Fuse	Note that there is a fuse (slow-blow 100mA) internal to the controller. Replace fuse with the recommended type only.

JP6 On the Analog PCB:
Selects between Pt100 and Pt1000. To switch between Pt100 and Pt1000, use tweezers or needle nose pliers to shift jumper from Position A to Position B.

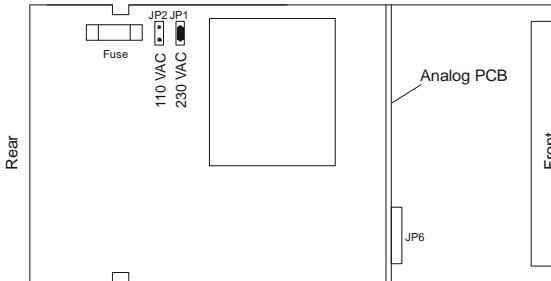

View from the top of Main PCB

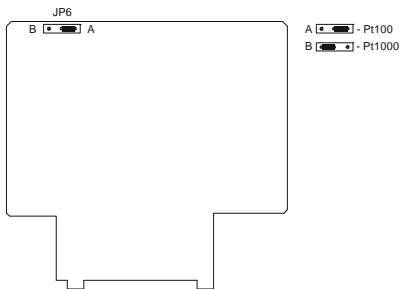

View from the front of the Analog PCB

12.2 Appendix 2 – Measurement Ranges available in the Controller

Range No.	Range	Resolution	Default cell K
1	0.000 – 1.999 μ S	0.001 μ S	0.01
2	0.00 – 19.99 μ S	0.01 μ S	0.01
3	0.00 – 19.99 μ S	0.01 μ S	0.1
4	0.0 – 199.9 μ S	0.1 μ S	0.1
5	0.0 – 199.9 μ S	0.1 μ S	1.0
6	0 – 1999 μ S	1 μ S	1.0
7	0 – 5000 μ S	5 μ S	1.0
8	0.00 – 19.99 mS	0.01 mS	1.0
9	0.0 – 199.9 mS	0.1 mS	10.0
0	0.0 – 199.9 mS	0.1 mS	1.0

12.3 Appendix 3 – Conductivity at Related Temperature Coefficients (25 °C)

Substance	Concentration wt %	Conductivity 10^{-4} S/cm	Conductivity Coefficient
NaOH	5	1969	2.01
	10	3124	2.17
	15	3463	2.49
	20	3270	2.99
	30	2022	4.50
KOH (15 C)	40	1164	6.48
	25.2	5403	2.09
	29.4	5434	2.21
	33.6	5221	2.36
NH ₃ (15 C)	42.0	4212	2.83
	0.10	2.51	2.46
	1.60	8.67	2.38
	4.01	10.95	2.50
	8.03	10.38	2.62
	16.15	6.32	3.01
HF	30.5	1.93	-
	1.5	198	7.20
	4.8	593	6.66
HNO ₃	24.5	2832	5.83
	6.2	3123	1.47
	12.4	5418	1.42
	31.0	7819	1.39
	49.6	6341	1.57
	62.0	4964	1.57

Substance	Concentration wt %	Conductivity 10 ⁻⁴ S/cm	Conductivity Coefficient
H ₃ PO ₄ (15°C)	10	566	1.04
	20	1129	1.14
	40	2070	1.50
	45	2087	1.61
	50	2073	1.74
NaCl	5	672	2.17
	10	1211	2.14
	15	1642	2.12
	20	1957	2.16
	25	2153	2.27
Na ₂ SO ₄	5	409	2.36
	10	687	2.49
	15	886	2.56
HCl	5	1969	1.58
	10	3124	1.56
	20	3463	1.54
	30	662	1.52
	40	5152	-
H ₂ SO ₄	5	2085	1.21
	10	3915	1.28
	20	6527	1.45
	40	6800	1.78
	50	54055	1.93
	60	3726	2.13
	80	1105	3.49
	100.14	187	0.30
CuSO ₄	5	109	2.13
	10	189	2.16
	20	320	2.18
	30	421	2.31
CH ₃ COOH	1	5.84	-
	10	15.26	1.69
	15	16.19	1.74
	20	16.05	1.79
	30	14.01	1.86
	40	10.81	1.95
Na ₂ CO ₃	5	456	2.52
	10	705	2.71
	15	836	2.94
KCl	5	690	2.01
	10	1359	1.88
	15	2020	1.79
	20	2677	1.68
	25	2810	1.66

Substance	Concentration wt %	Conductivity 10^{-4} S/cm	Conductivity Coefficient
KBr (15 C)	5	465	2.06
	10	928	1.94
	20	1907	1.77
KCN (15 C)	3.25	507	2.07
	6.5	1026	1.93
NH ₄ Cl	5	918	1.98
	10	1776	1.86
	15	2586	1.71
	20	3365	1.61
	25	4025	1.54
(NH ₄) ₂ SO ₄	5	552	2.15
	10	1010	2.03
	20	1779	1.93
	30	2292	1.91

12.4 Appendix 4 – Conductivity of Various Aqueous Solutions at 25°C

	Conductivity		Resistivity	
Pure Water	0.05	uS/cm	18	MΩ-cm
Power Plant Boiler Water	0.05 - 1	uS/cm	1 - 18	MΩ-cm
Distilled Water	0.5	uS/cm	2	MΩ-cm
De-ionized Water	0.1 - 10	uS/cm	0.1 - 10	MΩ-cm
De-mineralised Water	1 - 80	uS/cm	0.01 - 1	MΩ-cm
Mountain Water	10	uS/cm	0.1	MΩ-cm
Drinking Water	0.5 - 1	mS/cm	1 - 2	MΩ-cm
Waste-water	0.9 - 9	mS/cm	0.1 - 1	MΩ-cm
Potable Water Maximum	1.5	mS/cm	0.7	MΩ-cm
Brackish Water	1 - 80	mS/cm	0.01 - 1	MΩ-cm
Industrial Process Water	7 - 140	mS/cm	rarely stated	
Ocean Water	53	mS/cm	rarely stated	

12.5 Appendix 5 - Simple Explanation on the Function of Hysteresis

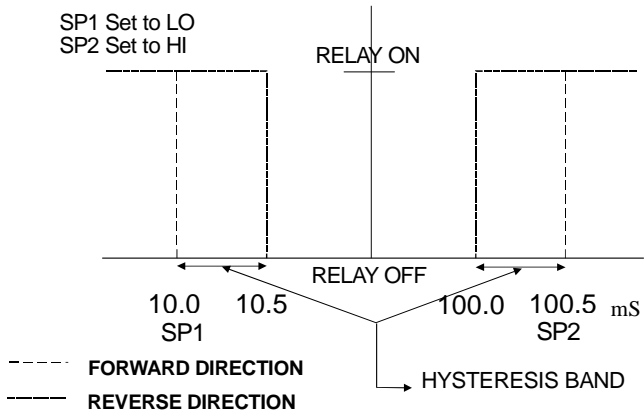

The controller relay activates when the set-point is reached. In the reverse direction, it does not de-activate when the value reaches the set-point. Instead, it continues to be active till the value reaches the amount set by the Hysteresis band.

12.6 Appendix 6 – General Instructions Concerning Controller Setting

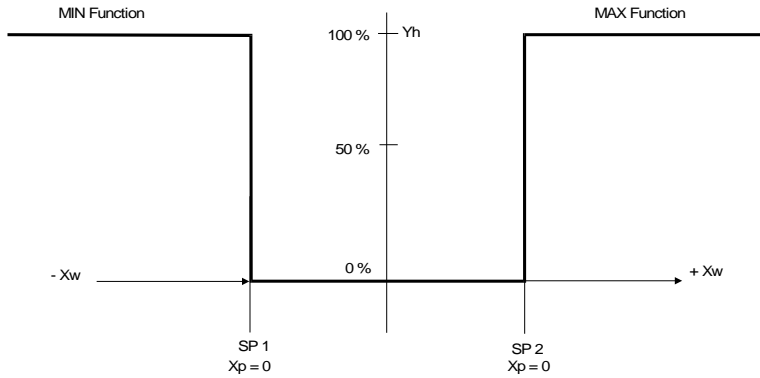

Control characteristic of P-Controllers as limit value switch

Water Analysis Instruments



North America

166 Cummings Center
Beverly, MA 01915 USA
Toll Free: 1-800-225-1480
Tel: 1-978-232-6000
Dom. Fax: 1-978-232-6015
Int'l Fax: 978-232-6031

Europe

P.O. Box 254, 3860 AG Nijkerk
Wallerstraat 125K, 3862 CN Nijkerk,
Netherlands
Tel: (31) 033-2463887
Fax: (31) 033-2460832

Asia Pacific

Blk 55, Ayer Rajah Crescent
#04-16/24, Singapore 139949
Tel: 65-6778-6876
Fax: 65-6773-0836

www.thermo.com/process

© 2009 Thermo Fisher Scientific Inc.

All rights reserved. Thermo Fisher Scientific Inc.