

Alpha DO 1000

Controller/Transmitter
mg/l / % saturation / °C



ROSS and the COIL trade dress are trademarks of Thermo Fisher Scientific Inc. U.S. patent 6,793,787.

AQUAfast, Cahn, ionplus, KNipHE, No Cal, ORION, perpHect, PerpHecT, PerpHecTion, pHISA, pHuture, Pure Water, Sage, Sensing the Future, SensorLink, ROSS, ROSS Ultra, Sure-Flow, Titrator PLUS and TURBO2 are registered trademarks of Thermo Fisher.

1-888-pHAX-ION, A+, All in One, Aplus, AQUAsnap, AssuredAccuracy, AUTO-BAR, AUTO-CAL, AUTO DISPENSER, Auto-ID, AUTO-LOG, AUTO-READ, AUTO-STIR, Auto-Test, BOD AutoEZ, Cable-Free, CERTI-CAL, CISA, DataCOLLECT, DataPLUS, digital LogR, DirectCal, DuraProbe, Environmental Product Authority, Extra Easy/Extra Value, FAST QC, GAP, GLPcal, GLPcheck, GLPdoc, ISEasy, KAP, LabConnect, LogR, Low Maintenance Triode, Minimum Stir Requirement, MSR, NISS, One-Touch, One-Touch Calibration, One-Touch Measurement, Optimum Results, Orion Star, Pentrode, pHuture MMS, pHuture Pentrode, pHuture Quatrode, pHuture Triode, Quatrode, QuiKcheK, rf link, ROSS Resolution, SAOB, SMART AVERAGING, Smart CheK, SMART STABILITY, Stacked, Star Navigator 21, Stat Face, The Enhanced Lab, ThermaSense, Triode, TRIUMpH, Unbreakable pH, Universal Access are trademarks of Thermo Fisher.

Guaranteed Success and The Technical Edge are service marks of Thermo Fisher.

PerpHecT meters are protected by U.S. patent 6,168,707. PerpHecT ROSS electrodes are protected by U.S. patent 6,168,707. ORION Series A meters and 900A printer are protected by U.S. patents 5,198,093, D334,208 and D346,753. ionplus electrodes and Optimum Results solutions are protected by U.S. patent 5,830,338. ROSS Ultra electrodes are protected by U.S. patent 6,793,787. ORP standard is protected by U.S. patent 6,350,367. No Cal electrodes are protected by U.S. patent 7,276,142. © 2009 Thermo Fisher Scientific Inc. All rights reserved. All trademarks are the property of Thermo Fisher Scientific Inc. and its subsidiaries. The specifications, descriptions, drawings, ordering information and part numbers within this document are subject to change without notice. This publication supersedes all previous publications on this subject.

Preface

This manual serves to explain the use of the Alpha DO 1000 series Dissolved Oxygen controller/transmitter. The manual functions in two ways: firstly as a step-by-step guide to help the user operate the instrument. Secondly, it serves as a handy reference guide. This instruction manual is written to cover as many anticipated applications of the Alpha DO 1000 Dissolved Oxygen controller/transmitter. If you have doubts in the use of the instrument, please do not hesitate to contact your nearest Alpha Authorised Distributor.

The information presented in this manual is subject to change without notice as improvements are made, and does not represent a commitment on part of Thermo Scientific.

Thermo Scientific cannot accept any responsibility for damage or malfunction of the unit due to improper use of the instrument.

Copyright ©2009

Safety Information

The Alpha Controller/ Transmitter shall be installed and operated only in the manner specified in the Instruction manual. Only skilled, trained or authorized person should carry out installation, setup and operation of the instrument.

Before powering up the unit, make sure that power source it is connected to, is as specified in the top label. Failure to do so may result in a permanent damage to the unit.

The unit has live and exposed parts inside. If it has to be opened, make sure that the power to the unit is off and disconnected.

The unit is Fuse protected. In the event the fuse has to be replaced, use only those as specified in the manual.

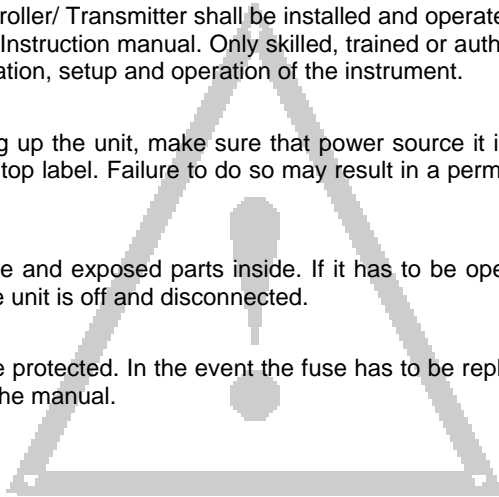

TABLE OF CONTENTS

1	INTRODUCTION	1
1.1	Description of Unit	1
1.2	Applications.....	1
2	ASSEMBLY AND INSTALLATION	2
2.1	Measurement and Control System	2
2.2	Unit Dimensions.....	2
3	ELECTRICAL CONNECTION	3
3.1	Connection Diagram	3
3.2	Back Panel	4
4	OVERVIEW.....	6
4.1	Keypad and Display	6
4.1.1	Keypad	6
4.1.2	Display.....	6
4.2	Function Groups	7
4.2.1	How to view operating parameters without access to change them:	7
4.3	Control Concept.....	8
5	MEASUREMENT	9
5.1	Display in Measurement mode	9
5.1.1	Check electrode performance	9
5.1.2	Checking set points	9
5.2	Security Codes	10
5.2.1	How to enter and change parameters in Calibration mode	10
5.2.2	Clearing the Calibration security code from the display	10
5.2.3	How to enter and change parameters in Advanced Setup mode.....	10
5.2.4	Clearing the Advanced Setup Security Code from the Display	11
6	CALIBRATION MODE	12
6.1	Dissolved Oxygen Calibration	12
6.2	Dissolved Oxygen Calibration in % Saturation of Oxygen	13
7	ADVANCED SET-UP MODE.....	15
7.1	Electrode Offset (OFS), Salinity and Pressure sub-function	15
7.2	Setting the Salinity Value	16
7.3	Setting the Pressure Value (mmHg or Pascal).....	16
7.4	Setting Temperature (Set °C) sub-function	17
7.4.1	Selecting Automatic or Manual Temperature Compensation.....	17
7.4.2	Temperature calibration (ATC mode only).....	17
7.4.3	Setting Manual Temperature Compensation.....	18
7.5	Control Relay A/Control Relay B (SP1/SP2) sub-function	18
7.5.1	Entering the Set point 1 (or Set point 2) sub-function	19
7.5.2	Selecting the Set Point Values	19
7.5.3	Choosing High or Low Set-points.....	19
7.5.4	Selecting a Hysteresis (Dead Band) Value	20
7.5.5	Setting an On-Delay Time Lag.....	20
7.5.6	Setting an Off-Delay Time Lag.....	21
7.6	Controller (Cnt) Sub-Function.....	22

7.6.1	Entering the Controller sub-function.....	22
7.6.2	Choosing the controller type (limit or proportional).....	22
7.6.3	Choosing Break/Make Contact Relay Type	23
7.6.4	Selecting Proportional Range Value, Xp.....	23
7.6.5	Maximum Pulse Length (tPL) or Maximum Frequency (FPF).....	24
7.7	Current Output (rng) sub-function	25
7.7.1	Entering Current Output sub-function.....	25
7.7.2	Choosing the Output Type.....	25
7.7.3	Selecting Dissolved Oxygen Value at 0(4)mA.....	25
7.7.4	Selecting Dissolved Oxygen value at 20mA.....	26
7.8	Configuration (ConF) sub-function	26
7.8.1	Entering the Configuration sub-function	26
7.8.2	Selecting the Units Of Measure (mg/l, ppm or %).....	27
7.8.3	Selecting the Alarm Time Lag	27
7.8.4	Selecting Steady or Pulse Contact for the Alarm Relay	27
7.8.5	Selecting Dissolved Oxygen Probe Type	28
7.8.6	Reverting to Factory Default Settings.....	28
7.9	Calibration (CAL) sub-function.....	29
7.9.1	Entering Calibration mode from Advanced Set-up mode	29
8	AUTO/MANUAL MODE	30
8.1	Auto Mode (Mode After Switch-On).....	30
8.2	Manual Mode	30
9	TECHNICAL SPECIFICATIONS	32
10	ACCESSORIES.....	33
10.1	Assembly Accessories	33
11	GENERAL INFORMATION	34
11.1	Warranty.....	34
11.2	Packaging	34
11.3	Return of Goods.....	34
11.4	Guidelines for Returning Unit for Repair	34
12	APPENDICES.....	35
12.1	Appendix 1 – Jumper Positions for 110 or 230 volts.....	35
12.2	Appendix 2 – Salinity vs Temperature (@ 760 mmHg).....	36
12.3	Appendix 3 - Explanation on the Function of Hysteresis	37
12.4	Appendix 4 – Limit and Proportional Control Functions	38

1 INTRODUCTION

1.1 Description of Unit

Thank you for purchasing the Thermo Scientific's ¼ DIN Alpha DO 1000 series Dissolved Oxygen process controller. This unit is used for measuring either in % saturation, mg/l or ppm, one at a time, and the operational mode is switchable from the menu. You can use this unit to measure Dissolved Oxygen with limit or proportional control. This controller has many user-friendly and safety features which include:

- **Menu-driven program** that simplifies set-up
- **Built-in Memory backup** to ensure that calibration data and other information are not erased if power supply fails
- **Push-button one-/two-point calibration and electrode offset adjustment** from the keypad
- **Automatic temperature compensation (ATC)**
- **Manual temperature compensation** with independent setting for calibration and process temperature
- 0 to 1999 second **time delay adjustment** on all relays – minimise false alarms
- Separately adjustable **high and low set point hysteresis** (dead bands) prevent chattering of relays around the set points
- **Three control modes:** limit control, proportional pulse length or proportional pulse frequency
- **Large dual display LCD** for easy reading with clear multiple annunciators, alarm status and operational message annunciators
- **Two switching contacts as set-point triggering relays** and an alarm output relay
- Separate **alarm relay** alerts you when set points have exceeded the limits and if the Pt100 wires are broken or disconnected during the ATC function
- **Hold** function freezes output current (**0/4...20mA**) and releases control relays
- **LED indicators** signal control activities to monitor controller status from a distance
- **Protection against electromagnetic interference** - galvanically isolated 0/4 - 20mA output provides safety for data logging and control purposes

1.2 Applications

Use this controller in panel mounted enclosures for applications such as water treatment and monitoring, galvanic-decontamination, chemical processing, food processing, clean or waste water control and neutralization process.

2 ASSEMBLY AND INSTALLATION

2.1 Measurement and Control System

A typical measurement system consists of:

- an Alpha DO 1000 process controller
- a Dissolved Oxygen probe with integrated temperature sensor Pt100
- an immersion, flow or process assembly
- a final control element such as pump or valve, and
- a chart recorder

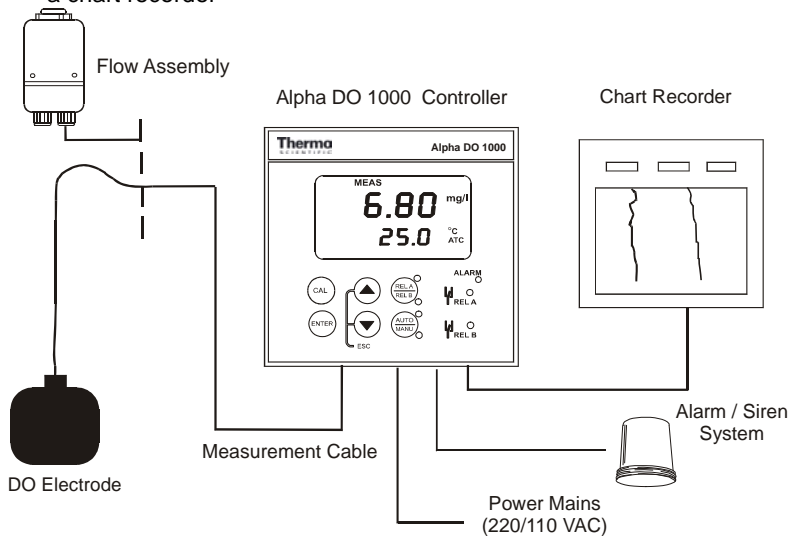

2.2 Unit Dimensions

The field-tested control panel housing is 96 x 96 mm; with protection class IP 54 (front).

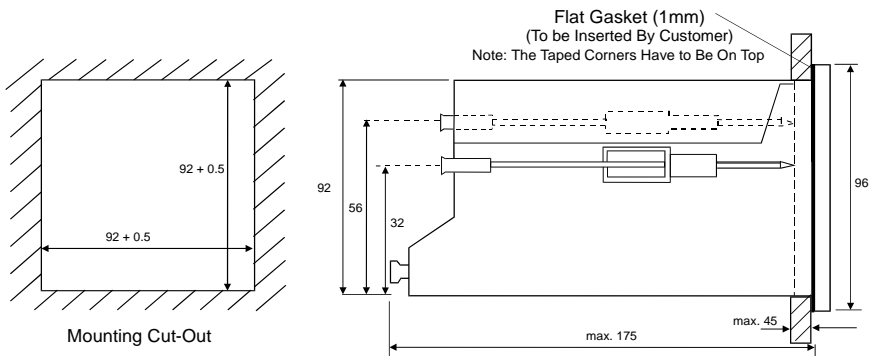

3 ELECTRICAL CONNECTION



ENSURE that the power cable is physically separated from the power supply.

3.1 Connection Diagram

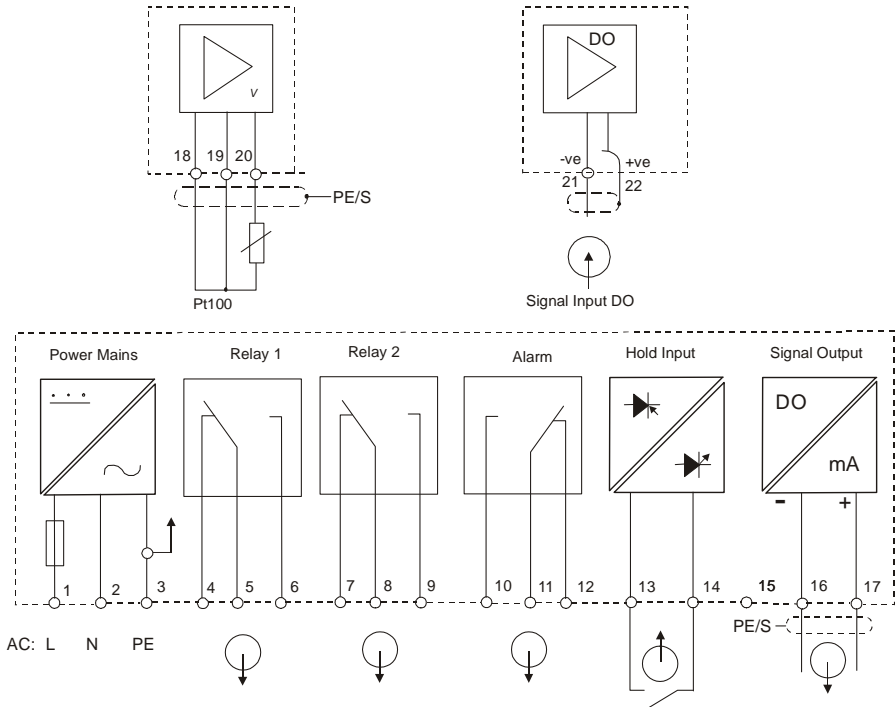

*) indicated contact positions are for currentless or no error conditions

3.2 Back Panel

The back panel consists of two connectors. The first connector is the 17-way PCB edge connector and the other is the 5-way connector.



ENSURE that the power cable is physically separated from the power supply.

Connection for the 17-way screw terminals (from left to right):

Pin No	Description	Pin No	Description
1	AC mains live wire	10	Alarm relay resting position (NO)
2	AC mains neutral wire	11	Alarm relay common
3	AC mains protective earth wire	12	Alarm relay working position (NC)
4	Low set relay resting position (NC)	13	Hold function switch terminal 1
5	Low set relay common	14	Hold function switch terminal 2
6	Low set relay working position (NO)	15	No connection
7	High set relay resting position (NC)	16	0/4 - 20 mA for -ve connection
8	High set relay common	17	0/4 - 20 mA for +ve connection
9	High set relay working position (NO)		

Connections for the 5-way screw terminals (please refer to DO probe wiring instruction manual):

Pin No	Description	DO Probe Wiring Colour
18	Pt100 lead 1	White
19	Pt100 sense lead	Red
20	Pt100 lead 2	Black
21	Cathode, -ve connection	Green
22	Anode, +ve connection	Yellow

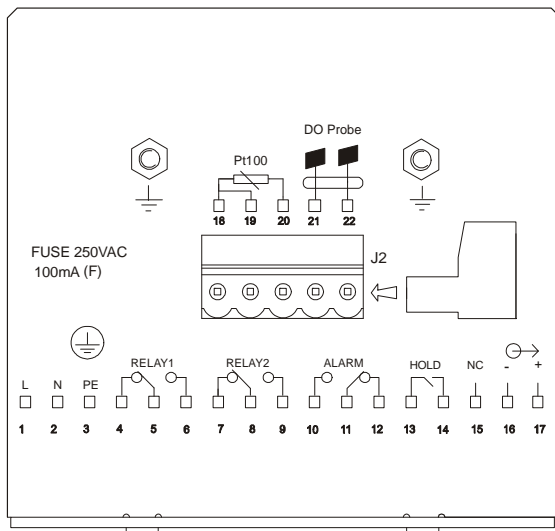

IMPORTANT: The Alarm relay functions as an “Active Low” device i.e. it switches OFF under Alarm condition. Therefore the Alarm display device should be connected to the ‘NC’ contacts of the relay.

4 OVERVIEW

4.1 Keypad and Display

4.1.1 Keypad



- Perform rapid calibration
-



- Allows entry to Set up mode
 - Select individual functions within the function group of Set up mode
 - Store input data in the Set up mode
 - Start calibration in the calibration mode
-

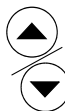

- Select various function groups in the Set up mode.
 - Set parameters and numerical values in sub functions of Set up mode
If pressed continuously, the setting speed increases
 - Control the relays in the MANUAL function
 - Return to the Measurement mode when both keys are pressed together
-



- Switch between AUTO and MANUAL relay operation using a code
-



- Display limit set-point values for the switch contacts in AUTO relay operation mode
 - Switch between RELAY A and RELAY B in MANUAL relay operation mode
-

4.1.2 Display

The LCD display features two numerical displays that show status messages and measured values for easy, quick reference. The display provides short-text information for setting parameters and configuration.

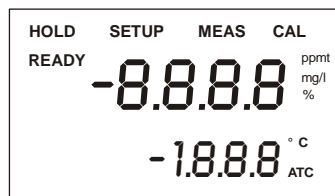

- **HOLD:** Relay position and current output are frozen
 - **SETUP:** Set-up mode of function groups
 - **MEAS:** Measurement mode
 - **CAL:** Calibration mode of Dissolved Oxygen
 - **READY:** Comes on after a successful calibration
 - **ATC:** Comes on in the ATC mode. Disappears in the Manual temperature Compensation mode. "ATC" flashes if the temperature probe is faulty in its ATC mode
-



- Display for RELAY A/B. Green LED indicates measured value within limit while RED LED indicates measured value outside limit.
-



- Alarm display if limit value overshoot or the ATC connection is broken.
-

4.2 Function Groups

The main function and sub-function groups are organised in a matrix format for configuration and selection of parameters. The main function groups are:

- Offset adjustment (**OFS**). See Section 7.1.
- Temperature Measurement / compensation settings (**SEt °C**). See Section 7.4.
- Control relay 1 configuration (**SP1**). See Section 7.5.
- Control relay 2 configuration (**SP2**). See Section 7.5.
- Control type (**Cntr**). See Section 7.6.
- Current output (**rng**). See Sections 7.7.
- Configuration (**ConF**). See Section 7.8.
- Calibration (**CAL dO**). See Sections 6 & 7.9.

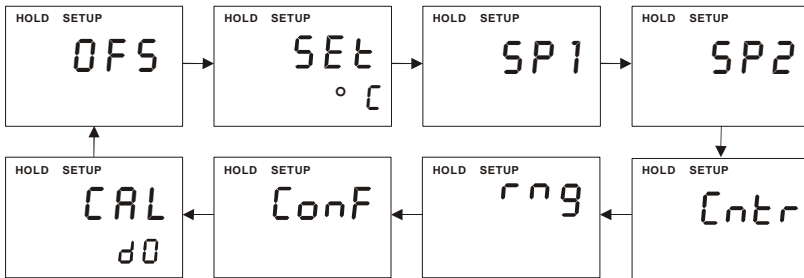

The set-up parameters can be viewed or changed by entering a security code. See Section 5.2 for security code information.

4.2.1 How to view operating parameters without access to change them:

1. Press the ENTER key. The display will prompt the user to enter a security code (S.Cd). Leave the security code at "000" (do not enter a security code).
2. Press ENTER key again. This allows you only to view (not change) any sub-functions' settings.
3. Press the ▲ or ▼ keys to scroll through the sub-functions.
4. Press the ENTER key at a particular sub-function to view in detail.
5. Press the ENTER key to return to the sub-function menu.
6. Press the ▲ or ▼ keys simultaneously (as an Escape key) at any time to return to the Measurement mode.

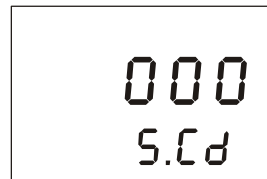

Note: To simplify operations, the controller will not display parameters that are not relevant to a particular sub-function. For example: If the user set the controller for Limit control, it will not display pulse length/frequency settings.

4.3 Control Concept

The main function and sub-function groups are organised in a matrix format as shown below. These functions can be accessed via the front keypad for configuration and selection of parameters.

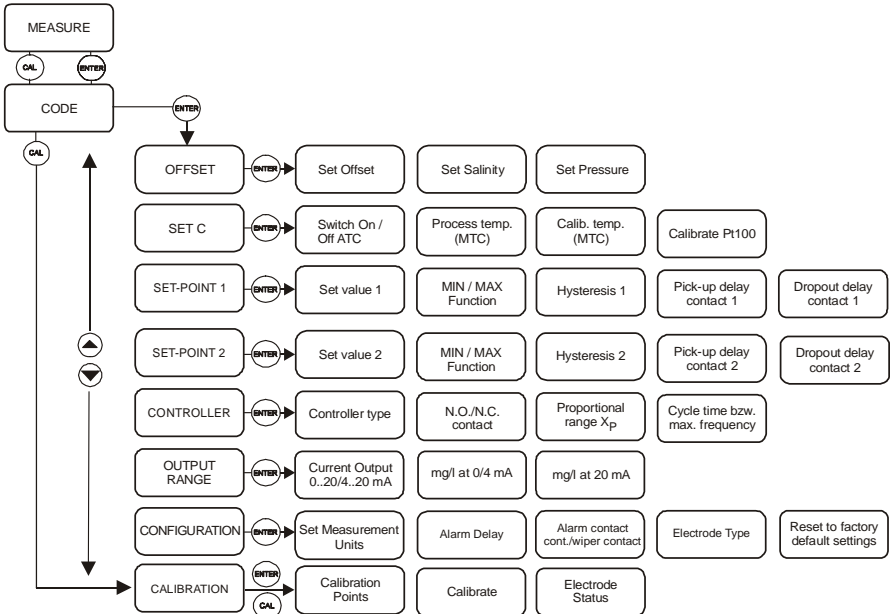

The controller offers two levels of password protection: (1) for direct access to calibration function and (2) for setting or editing specific controller parameters or functions in the SETUP mode to suit individual requirements.

Note: The passwords are not user-defined and have been set by factory. It is very important to keep these passwords strictly confidential to avoid unauthorised tampering of the system at all times.

Note: If the user reads parameters only, the controller automatically reverts to Measurement mode if none of the keys is pressed for 30 seconds.

5 MEASUREMENT

5.1 Display in Measurement mode

When the controller is initially powered on, it automatically enters into the Measurement mode after the large dual LCD displays all segments briefly.

The upper display shows the measured Dissolved Oxygen value, while the lower display shows the temperature value. Annunciators at the right side of the display indicate measurement units: ppm, mg/l or % measurement. Similarly annunciators or icons at the top or left side of the display shows the current status of controller, e.g. "HOLD", "SETUP", "MEAS", "CAL", "READY", etc.

5.1.1 Check electrode performance

To read current electrode slope and offset values without changing them:

1. Press the CAL key followed by the ENTER key without adjusting the security code (leave code at "000"). The upper display shows the condition of the probe. The lower display reading shows the temperature reading.
2. Press the ENTER key a second time to return to Measurement mode.

<p><i>Note: If security code is changed to a value other than "000", pressing the ENTER key will return to the Measurement mode, without displaying electrode information.</i></p>
--

5.1.2 Checking set points

To read current set point values without changing them:

1. Press the RELAY Selection (Rel A / Rel B) key. The upper display shows the set point for Relay A; the lower display shows "SP1".
2. After two seconds the upper display shows the set-point value for Relay B; the lower display shows "SP2".
3. After an additional two seconds, the controller returns to the Measurement mode.

5.2 Security Codes

This controller has two levels of security protection with separate security codes. The first level allows entry into the Calibration mode: security code = 11; the second allows entry into the SETUP mode: security code = 22.

The security codes protect the controller from unauthorised tampering of its current setting. The parameters cannot be changed unless the security code is entered.

5.2.1 How to enter and change parameters in Calibration mode

1. Press the CAL key. The upper display shows “000” and the lower display shows “C.Cd” to prompt the user to enter the Calibration security code.
2. Press the ▲ or ▼ keys to scroll upper display to Calibration security code “11”.
3. Press the ENTER key. The display shows “CAL dO”.
4. Press ENTER key again to begin calibration. Refer to Section 6 for full details on calibration.
5. Press the ▲ or ▼ keys simultaneously (escape) to return to the Measurement mode.

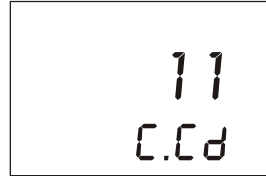

NOTE: To view (not change) the SETUP parameters, push the ENTER key when the security code reads “000”.

5.2.2 Clearing the Calibration security code from the display

The calibration security code automatically resets from “11” to “000” after you return to Measurement mode, so you do not need to clear the security code from the display.

5.2.3 How to enter and change parameters in Advanced Setup mode

1. Press the ENTER key once. The upper display shows “000” and the lower display shows “S.Cd” to prompt you to enter the Advanced Setup security code.
2. Press the ▲ or ▼ keys to scroll the display to Setup security code “22”. NOTE: Pressing the ENTER key at a value other than “22” causes the controller to revert to the Measurement mode.
3. Press the ENTER key.
4. The upper display reads “OFS”.
5. You are now in the Advanced Setup mode. See Section 7 for complete instructions. To return to Measurement mode, press the ▲ or ▼ keys simultaneously (escape).

NOTE: If you want to view (not change) set up parameters, push the ENTER key when the security code reads "000".

5.2.4 Clearing the Advanced Setup Security Code from the Display

After you have entered the security code and returned to the Measurement mode, the security code "22" still appears on the display whenever you press the ENTER key. To conceal the security code, you must manually reset the code. To clear the Advanced Setup security code from the display:

1. Press the ENTER key in the Measurement mode.
2. Set to any security code (not 11 or 22) and complete by pressing ENTER.

NOTE: When you enter the Calibration mode with code "11" or Advanced Setup mode with security code "22", the unit automatically enters into the HOLD mode until you return back to Measurement mode. The HOLD annunciator is displayed at the upper left of the display. While on HOLD, the current output is frozen and set point relays are deactivated.

6 CALIBRATION MODE

You can reach the Calibration mode directly from the Measurement mode by pressing the CAL key and entering the Calibration security code. You can also reach the Calibration mode from the Advanced Setup mode.

6.1 Dissolved Oxygen Calibration

If the units of measure is in mg/l (default), then the calibration is also carried out in mg/l. The Dissolved Oxygen Controller allows a one- or two-point calibration.

1. Enter Calibration mode. While in the Measurement mode, push the CAL key and scroll to Calibration code "11". Push the ENTER key again. The upper and lower display reads "CAL dO".
2. Press the ENTER key. Use the ▲ or ▼ keys to select 1- or 2-calibration points.
3. For **One-Point Calibration**, only Hi-value calibration is possible. The probe is allowed to equilibrate in a solution containing 8.24 mg/l of dissolved oxygen. The "CAL" indicator flashes at the top, right-hand corner. When reading is stable, the "READY" annunciator comes on. Use the ▲ or ▼ keys to adjust the displayed value to the correct value. Press ENTER key to accept the value and the controller displays the status of the probe.
4. For **Two-Point Calibration**, calibration is carried out at the Lo-value first, usually zero oxygen solution. Immerse the probe in the solution (low levels of dissolved oxygen) and allow it to stabilise. When the reading is stable, the "READY" annunciator comes on. Use the ▲ or ▼ keys to adjust the displayed value to the correct value. Press the ENTER key to accept the value.

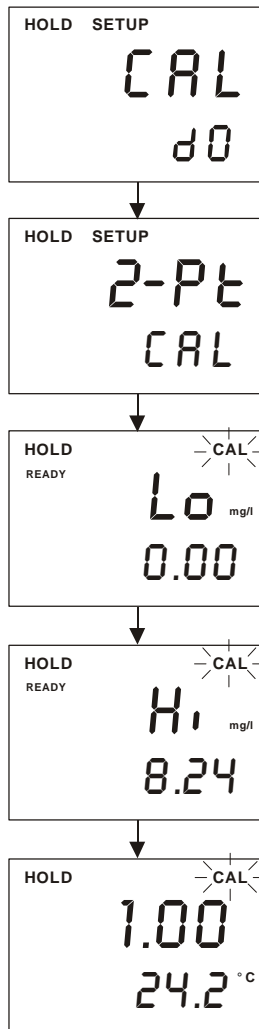

NOTE: If the displayed value is $> \pm 0.4$ mg/l, the controller will not accept the zero calibration and retains the previous calibration values.

5. If the calibration is successful, the controller switches to the second point, which is the high-level of dissolved oxygen. Take the probe out of the solution and immerse it in a solution with a higher concentration of dissolved oxygen. When the reading is stable, "READY" annunciator comes on. Use the ▲ or ▼ keys to adjust the displayed value to the correct value. Press ENTER key to accept the value and the status of the probe is displayed.

NOTE: If the displayed value is $> \pm 2$ mg/l, the controller will not accept the high-level calibration and retains the previous calibration values.

6. After calibration, the controller automatically displays the condition of the probe in the upper display and the temperature in the lower display. You can view these values without calibration --- see Section 5.1.1 for instruction. The probe condition is re-determined after each calibration.
7. Press the ENTER key. If you entered the calibration mode using the CAL key, the controller will return to the Measurement mode. If you entered the calibration mode from the Advanced Set-up mode, the controller will return to the sub-function menu.

NOTE: If there is a calibration error, the controller displays "ERR". If this happens, push both the ▲ or ▼ keys (escape) to restart the calibration beginning from Step 1.

NOTE: When calibrating with manual temperature compensation, the controller automatically changes from the preset process temperature to the calibration temperature. After leaving the Calibration mode, the controller switches back to process temperature (for setting the calibration temperature and the process temperature, see Section 7.4.3).

6.2 Dissolved Oxygen Calibration in % Saturation of Oxygen

A one-point calibration is done in air. When you carry out a two-point calibration, you need a standard D.O. buffer solution that matches the low value, which is 0%.

1. Enter Calibration mode. While in the Measurement mode, push the CAL key and scroll to Calibration code "11". Push the ENTER key again. The upper and lower display reads "CAL dO".
2. Press the ENTER key. Use the ▲ or ▼ keys to select 1- or 2-pt calibration points.
3. For **One-Point Calibration**, only calibration at the 100% level is possible. The probe is allowed to equilibrate with air. The "CAL" indicator flashes at the top, right-hand corner. When the reading is stable, the "READY"

annunciator comes on. Press ENTER key to accept the value and the controller displays the status of the probe.

4. For **Two-Point Calibration**, calibration is carried out at 0% saturation first. Immerse the probe in solution and allow it to stabilise. When the reading is stable, the "READY" annunciator comes on. Press the ENTER key to accept the value.

Note: If the displayed value is $> \pm 5\%$ of the theoretical value, the controller will not accept the zero calibration and retains the previous calibration values.

5. If the calibration is successful, the controller switches to the second point, 100% saturation. Take the probe out of the zero solution, rinse in clean water and calibrate in air. When the reading is stable, "READY" annunciator comes on. Press ENTER key to accept the value and the controller displays the status of the probe.

Note: If the displayed value is $> \pm 30\%$ of the theoretical value, the controller will not accept the high-level calibration and retains the previous calibration values.

6. After calibration to a second value, this controller will automatically display condition of the probe in the upper display and the temperature in the lower display. You can view these values without calibration --- see section 5.1.1 for instruction. The probe condition is re-determined after each calibration.
7. Press the ENTER key. If you entered the calibration mode using the CAL key, the controller will return to the Measurement mode. If you entered the calibration mode from the Advanced Set-up mode, the controller will return to the sub-function menu.

Note: If there is a calibration error, the controller displays "ERR". If this happens, push both the ▲ and ▼ keys (escape) to restart the calibration beginning from step 1.

Note: When calibrating with manual temperature compensation, the controller automatically changes from the preset process temperature to the calibration temperature. After leaving the Calibration mode, the controller switches back to process temperature (for setting the calibration temperature and the process temperature, see section 7.4.3).

7 ADVANCED SET-UP MODE

7.1 Electrode Offset (OFS), Salinity and Pressure sub-function

This mode allows you to change the offset parameter to make reading corrections without removing the electrode from the control system. You can make adjustments of up to ± 2.00 ppm; ± 2.00 mg/l; or $\pm 10.0\%$. At the end of the offset adjustment, the salinity value, followed by the pressure values (in mmHg or Pascal) respectively, is entered.

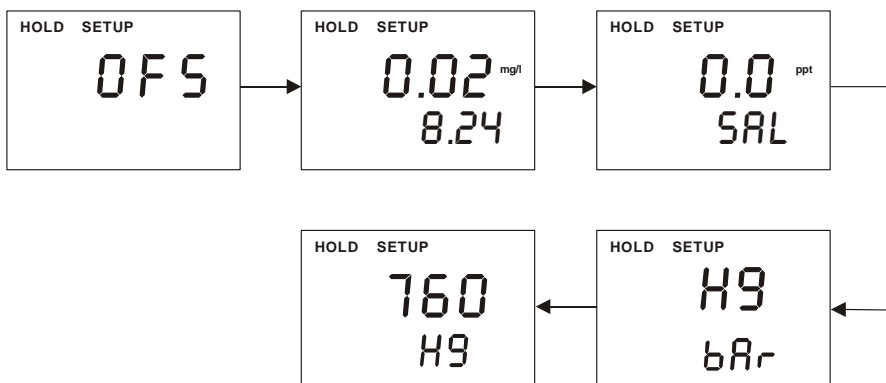

1. In this mode, the controller will add or subtract the value from the measured dissolved oxygen value and display the correct value. However, if you need to offset the value beyond the average offset you would expect in your application type, consider a full calibration or even electrode replacement.
2. Take a sample from the system. Record the controller's Dissolved Oxygen reading at the time the sample was taken.
3. Measure the Dissolved Oxygen of your sample using a calibrated Dissolved Oxygen hand-held meter or bench meter (*For a list of Thermo Scientific Instruments' DO hand-held meter, refer to section on Accessories*).
4. Record the correct Dissolved Oxygen value.
5. Enter Advanced set-up mode. Push the ENTER key and scroll to Advanced Set-up security code "22". Push the ENTER key again.
6. Press the ▲ or ▼ keys to scroll until the upper display shows "OFS".
7. Press the ENTER key. The SETUP annunciator appears at the top of the display. The lower display shows the current measured Dissolved Oxygen with its respective units. The upper display shows the current offset value.

8. Press the ▲ or ▼ keys until the Dissolved Oxygen value coincides with the correct Dissolved Oxygen value noted in Step 2. As the ▲ or ▼ keys is pressed to adjust the Dissolved Oxygen value, you will see that the 'offset' value in its upper display also changes.
9. Press the ENTER key to accept the offset value. Note: The offset value is reset during full calibration (See section 6).
10. Proceed to input Salinity values or return to Measurement mode by pressing the ▲ and ▼ keys (escape) simultaneously.

7.2 Setting the Salinity Value

1. Enter Advanced set-up mode. Push the ENTER key and scroll to Advanced Set-up security code "22". Push the ENTER key again.
2. Press the ▲ or ▼ keys to scroll until the upper display shows OFS.
3. Press the ENTER key till the upper display shows the "salinity value" in ppt, while the lower display shows "SAL". **(This function is not available in the % mode and this window is not displayed)**
4. Press the ▲ or ▼ keys until the salinity value (between 0.0 ppt and 50.0 ppt) coincides with the correct salinity value.
5. Press the ENTER key to accept the Salinity value. The controller automatically corrects for the final Dissolved Oxygen measurement.
6. Proceed to Section 7.3 to input the Pressure values or return to Measurement mode by pressing the ▲ or ▼ keys (escape) simultaneously.

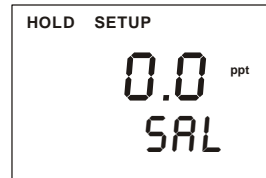

7.3 Setting the Pressure Value (mmHg or Pascal)

1. Enter Advanced set-up mode. Push the ENTER key and scroll to Advanced Set-up security code "22". Push the ENTER key again.
2. Press the ▲ or ▼ keys to scroll until the upper display shows OFS.
3. Press the ENTER key till the upper display shows "Hg" and the lower display shows "bar".
4. Press the ▲ or ▼ keys to select the units of pressure: if in mmHg, upper display shows "Hg" and lower display shows "bar"; or in Pascal, upper display shows "Pa" and lower display shows "bar".
5. Press the ENTER key to accept the units of measure for pressure. Use the ▲ or ▼ keys to scroll the correct pressure.

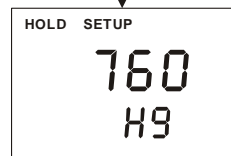
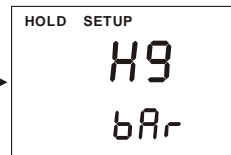
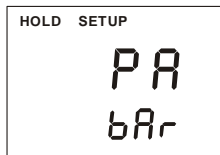

6. Press the ENTER key to accept the correct pressure values. The controller automatically compensates the final Dissolved Oxygen measurement.
7. Proceed with additional Advanced Set-up procedures (press ENTER again) or return to Measurement mode by pressing the ▲ or ▼ keys (escape) simultaneously.

7.4 Setting Temperature (Set °C) sub-function

7.4.1 **Selecting Automatic or Manual Temperature Compensation**

1. Enter Advanced Set-up mode. Push the ENTER key and scroll to Advanced Set-up security code "22". Push the ENTER key again.
2. Press the ▲ or ▼ keys to scroll until the upper display shows "Set °C".
3. Press the ENTER key. The lower display shows "Atc"; the upper display shows "on" (Section 7.4.1.1) or "oFF" (Section 7.4.1.2) depending on whether or not ATC is selected.
4. Press the ▲ or ▼ keys to toggle between ATC on and off.
5. Proceed with additional Advanced Set-up procedures (press ENTER again) or return to Measurement mode by pressing the ▲ or ▼ keys (escape) simultaneously.

A rectangular display box with "HOLD SETUP" at the top left. The main display area shows "SEt" on the top line and "°C" on the bottom line.

A rectangular display box with "HOLD SETUP" at the top left. The main display area shows "on" on the top line and "Atc" on the bottom line.

A rectangular display box with "HOLD SETUP" at the top left. The main display area shows "oFF" on the top line and "Atc" on the bottom line.

7.4.2 **Temperature calibration (ATC mode only)**

1. Select "ATC on" as described above in Section 7.4.1.
2. Press the ENTER key. The upper display indicates the current temperature offset. The current measured temperature is shown in the lower display.
3. Compare the current measured temperature on the controller display to a thermometer known to be accurate. Note down the correct temperature value.
4. Press the ▲ or ▼ keys to scroll the lower display to match the correct value. The upper display will now show the offset value. You can offset the temperature values to ± 5 °C.
5. Press the ENTER key to confirm your selection.
6. Continue with additional Advanced Set-up procedures, or return to the Measurement mode by pressing the ▲ or ▼ keys (escape) simultaneously.

A rectangular display box with "HOLD SETUP" at the top left. The main display area shows "on" on the top line and "Atc" on the bottom line.

A rectangular display box with "HOLD SETUP" at the top left. The main display area shows "0.0 °C" on the top line and "25.0 ATC" on the bottom line.

7.4.3 Setting Manual Temperature Compensation

Note: This parameter is blanked out when the controller is set for ATC operation.

For manual temperature compensation, you can set two different temperatures: process and calibration. This allows calibration at a temperature other than your process temperature. Example: setting a calibration temperature of 25 °C lets you calibrate using standard buffer solutions at 25 °C, even if your process temperature is a different temperature.

1. Select "ATC OFF" as described above in section 7.4.1
2. Press the ENTER key. The upper display shows the current process temperature and the lower display shows "P.°C" to indicate process temperature.
3. Press the ▲ or ▼ keys to adjust the process temperature value. You can adjust the value from – 9.9 to 125 °C.
4. After you set the process temperature value, press the ENTER key. The upper display shows the current calibration temperature and the lower display shows "C.°C" to indicate calibration temperature.
5. Press the ▲ or ▼ keys to adjust the calibration temperature value. You can adjust this value from – 9.9 to 125 °C.
6. Press the ENTER key to confirm your selection.
7. Continue with additional Advanced Set-up procedures, or return to Measurement mode by pressing the ▲ or ▼ keys (escape) simultaneously.

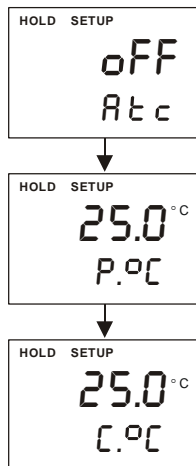

7.5 Control Relay A/Control Relay B (SP1/SP2) sub-function

The SP1 option sets the operating parameters for Relay A; and SP2 for relay B. Since these groups have the same set-up parameters, they are described together.

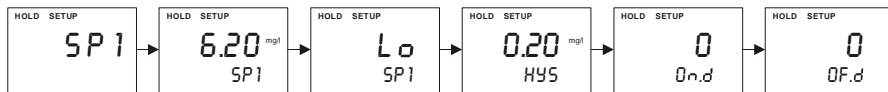

7.5.1 Entering the Set point 1 (or Set point 2) sub-function

1. Enter Advanced Set-up mode. Push the ENTER key and (use ▲ or ▼ keys to) scroll to Advanced Set-up security code “22”. Push the ENTER key again.
2. Press the ▲ or ▼ keys to scroll until the upper display shows SP1 (or SP2).

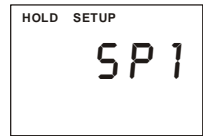

7.5.2 Selecting the Set Point Values

This lets you choose the value that will cause your controller to activate (Default: SP1 = 6.20mg/l; SP2 = 4.00mg/l).

1. Follow directions in 7.5.1 to enter Control Relay mode. If you are in this mode, skip to step 2.
2. Press the ENTER key. The upper display shows the current set point values and the lower display shows SP1 (SP2).
3. Press the ▲ or ▼ keys to select your value for Set point 1 (Set point 2). Your controller will activate at the value you select.
4. Press the ENTER key to confirm your selection.
5. Proceed to 7.5.3, or return to Measurement mode by pressing the ▲ or ▼ keys simultaneously (escape).

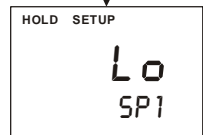

7.5.3 Choosing High or Low Set-points

Select “low” activate controller when the dissolved oxygen value undershoots the set point; select “high” activate controller when the value overshoots the set point. Using both SP1 and SP2, you can select Lo/Lo, Lo/Hi, Hi/Lo, or Hi/Hi set points (Default: SP1 = Lo; SP2 = Lo).

1. Follow directions in 7.5.1 to enter Control Relay mode. If you are in this mode, skip to step 2.
2. Press the ENTER key until the upper display shows Lo or Hi and the lower display shows SP1 (SP2).
3. Press the ▲ or ▼ keys to select low (lo) or high (hi) for SP1 (SP2).
4. Press the ENTER key to confirm your selection.
5. Proceed to 7.5.4, or return Measurement mode by pressing the ▲ or ▼ keys simultaneously (escape).

7.5.4 Selecting a Hysteresis (Dead Band) Value

Hysteresis prevents rapid contact switching if the value is fluctuating near the set point. It does this by overshooting the set point value to a specified hysteresis value (default is 0.20 mg/l or 2.5%). You can set the hysteresis value from 0.1 to 10 mg/l, 0.1 to 10 ppm or 1 to 10%.

Example: You have set your set point 1 (Lo) at 6.20 mg/l and your hysteresis limit value is at 0.5 mg/l. If your measured value undershoots the low set point of 6.20 mg/l, the controller's relay activates, which in turn activates an external device such as a pump or valve. The actions of the external device will cause the value to rise above 6.20 mg/l. When the value has increased to 6.70 mg/l, the relay, and hence the pump will switch off.

1. Follow directions in 7.5.1 to enter Control Relay mode. If you are in this mode, skip to step 2.
2. Press the ENTER key until the upper display shows the hysteresis (dead band) value and the lower display shows "HYS".
3. Press the ▲ or ▼ keys to enter your hysteresis value for Set point 1 (Set point 2). Your controller will activate at the value you select. Note: All settings for SP1 and SP2 are completely independent of each other.
4. Press the ENTER key to confirm your selection.
5. Proceed to 7.5.5, or return to Measurement mode by pressing the ▲ or ▼ keys simultaneously (escape).

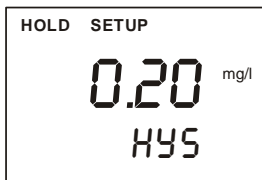

NOTE: Please refer to Appendix 3 for a graphical representation of the Hysteresis.

7.5.5 Setting an On-Delay Time Lag

You can set a time delay for each relay, which stops the relay from switching on the moment the set point is exceeded. This controller lets you set a 0 to 1999 seconds time delay before the relay activates.

1. Follow directions in 7.5.1 to enter Control Relay mode. If you are in this mode, skip to step 2.
2. Press the ENTER key. Scroll with the ▲ and ▼ keys until the upper display shows "0" time and the lower display shows "On.d".
3. Press the ▲ or ▼ keys to enter on-delay time for Set point 1 (Set point 2). The controller will delay activation for the number of seconds (0 to 1999) you select.
4. Press the ENTER key to confirm your selection.

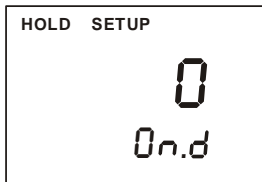

5. Proceed to 7.3.6, or return to Measurement mode by pressing the ▲ and ▼ keys simultaneously (escape).

7.5.6 Setting an Off-Delay Time Lag

You can set a time delay for each relay, which stops the relay from switching off the moment the value reached the set point and hysteresis. This controller lets you set a 0 to 1999 seconds time delay before your relay deactivates.

1. Follow directions in 7.5.1 to enter Control Relay mode. If you are in this mode, skip to step 2.
2. Press the **ENTER** key. Scroll with the ▲ or ▼ keys until the upper display shows "0" time and the lower display shows "OF.d".
3. Press the ▲ or ▼ keys to enter on-delay time for Set point 1 (Set point 2). Your controller will delay activation for the number of seconds (0 to 1999) you select.
4. Press the **ENTER** key to confirm your selection.
5. Continue with Advanced Set-up mode procedures, or return to Measurement mode by pressing the ▲ and ▼ keys simultaneously (escape).

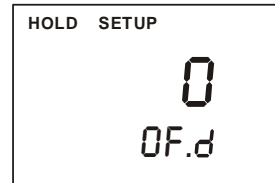

7.6 Controller (Cntr) Sub-Function

You can set the controller's parameters in this sub-function.

7.6.1 Entering the Controller sub-function

1. Enter Advanced Set-up mode. Push the **ENTER** key and scroll to Advanced set-up security code "22". Push the **ENTER** key again.
2. Press the **▲** or **▼** keys to scroll until the upper display shows "Cntr".

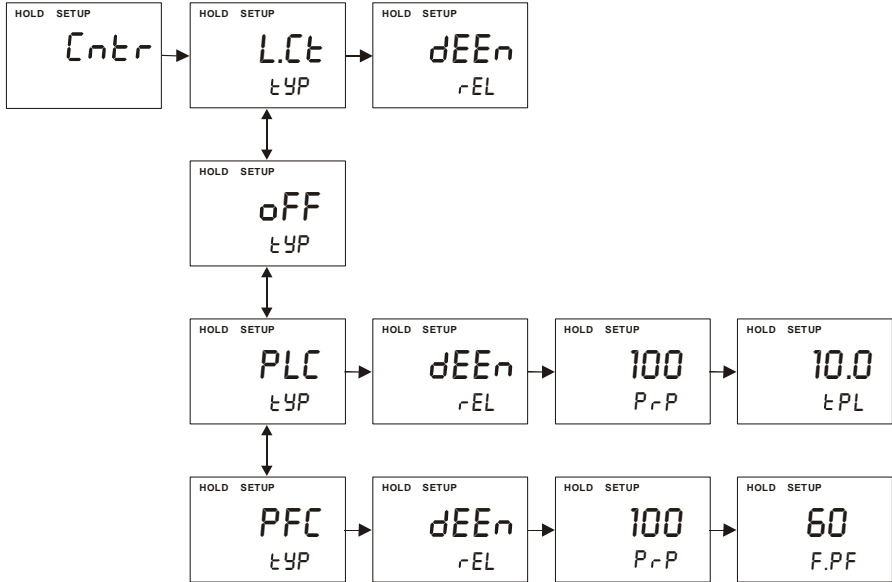

7.6.2 Choosing the controller type (limit or proportional)

This mode lets you choose your controller type: limit control, pulse length proportional control, pulse frequency proportional control, or control off.

- Use limit control with pumps or valves for fast response.
 - Use pulse frequency proportional control to operate your pumps smoothly
 - Use pulse length proportional control for precise control of proportional valves.
 - Use control off to operate controller as a monitor only or to prevent relays from switching.
1. Follow directions in 7.6.1 to enter Controller mode.
 2. Press the **ENTER** key. The upper display shows the current controller type and the lower display shows "tyP".

3. Press the ▲ or ▼ keys to select your controller type.
 - L.Ct = limit value pickup (on/off control).
 - oFF = controller off.
 - PLC= pulse length control
 - PFC= pulse frequency control
4. Press the **ENTER** key to confirm your selection.
5. Proceed to 7.6.3, or return to Measurement mode by pressing the ▲ and ▼ keys simultaneously (escape).

7.6.3 Choosing Break/Make Contact Relay Type

Note: If the controller type "oFF" is set, the parameters listed in 7.6.3, 7.6.4, and 7.6.5 are blanked out.

This mode lets you determine the relay-state under Non-Alarm condition – dEEN (de-energised) or EN (energised).

1. Follow directions in 7.6.1 to enter Controller mode.
2. Press the ENTER key. Scroll until the lower display shows "rEL" and the upper display shows the current selection (de-energised = dEEN or energised = EN).
3. Press the ▲ or ▼ keys to choose de-energised or energised relay state.
4. Press the ENTER key to confirm your selection.
5. Continue with Advanced Set-up mode procedures, or return to Measurement mode by pressing the ▲ and ▼ keys simultaneously (escape).

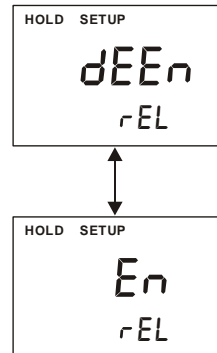

7.6.4 Selecting Proportional Range Value, Xp

Note: If the controller type "oFF" is set, the parameters listed in 7.6.3, 7.6.4, and 7.6.5 are blanked out.

This mode lets you set a band as a percentage of its full scale value. You can select this range from 10 to 200%, and the lower display shows "PrP".

1. Follow directions in 7.6.1 to enter Controller mode.
2. Press the **ENTER** key. Follow directions in 7.6.2 and select either "PLC" (pulse length control) or "PFC" (pulse frequency control). Press **ENTER** key.
3. Press the **ENTER** key until the upper display shows the proportional range (a number from 10 to 200%), and the lower display shows "PrP".
4. Press the ▲ or ▼ keys to choose the proportional range value Xp.

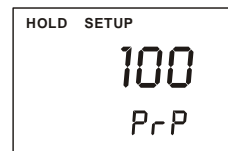

5. Press the **ENTER** key to confirm your selection.
6. Proceed to 7.6.5, or return to Measurement mode by pressing the **▲** and **▼** keys simultaneously (escape).

7.6.5 Maximum Pulse Length (tPL) or Maximum Frequency (FPF)

Note: If the controller type "oFF" is set, the parameters listed in 7.6.3, 7.6.4, and 7.6.5 are blanked out.

This mode lets you set the maximum pulse length or the maximum frequency at which the relay will operate.

1. Follow directions in 7.6.1 to enter Controller mode.
2. Press the **ENTER** key. Scroll until the lower display shows "t.PL" or "F.PF".
3. In PLC (pulse length) mode: The lower display shows "t.PL" to indicate pulse length. The upper display shows your current pulse length. You can select any value from 0.5 to 20 seconds.



Pulse Length (PLC) mode

4. In PFC (pulse frequency) mode: The lower display shows "F.PF" to indicate pulse frequency. The upper display shows your current maximum pulse rate. You can select any value from 60 to 120 pulses per minute. When the measured value exceeds the Proportional Band in 7.4.4, the controller will pulse the relay at this rate.

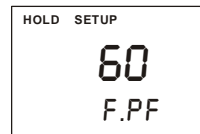

Pulse Frequency (PFC) mode

5. Press the **▲** or **▼** key to choose the period duration or maximum frequency, depending on your mode.
6. Press the **ENTER** key to confirm your selection and to return to Advanced Set-up mode, or return to Measurement mode by pressing the **▲** and **▼** keys simultaneously (escape).

Note: The alarm contact is always of the fail-safe type. In the event of power failure the alarm is triggered.

7.7 Current Output (rng) sub-function

This sub-function lets you set the transmitter current output range of this unit. The difference between the upper and lower range has to be a minimum of 20% in the “%” mode or 2mg/l in the “mg/l” mode, anywhere on the scale. (Hence, if 4mA = 4mg/l or 20%, then the closest range for the the 20mA = 6mg/l or 40%).

7.7.1 Entering Current Output sub-function

1. Enter Advanced Set-up mode. Push the ENTER key and scroll to Advanced Set-up security code “22”. Push the ENTER key again.
2. Press the ▲ or ▼ keys to scroll until the upper display shows “rng”. Press ENTER.

7.7.2 Choosing the Output Type

This parameter lets you choose between 0-20 mA or 4-20 mA output.

1. Follow directions in 7.7.1 to enter Current Output mode.
2. Press the ▲ or ▼ keys to select your output type: 0 – 20 or 4 – 20 mA.
3. Press the **ENTER** key to confirm your selection.
4. Proceed to 7.6.3, or return to Measurement mode by pressing the ▲ and ▼ keys simultaneously (escape).

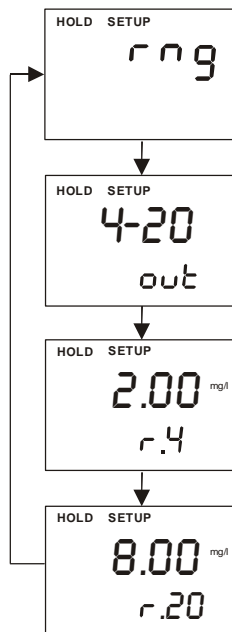

7.7.3 Selecting Dissolved Oxygen Value at 0(4)mA

This parameter lets you choose the Dissolved Oxygen value at which the transmitter output will be 0(4) mA.

1. Follow directions in 7.7.1 to enter Current Output mode.
2. Press the **ENTER** key until the upper display shows a Dissolved Oxygen value and the lower display shows “r.0(4)”.
3. Press the ▲ or ▼ keys to select dissolved oxygen value to be equivalent to 0(4) mA (Default is 2.00mg/l or 0%).
4. Press the **ENTER** key to confirm your selection and proceed to 7.7.4 or return to Measurement mode by pressing the ▲ and ▼ keys simultaneously (escape).

7.7.4 Selecting Dissolved Oxygen value at 20mA

This parameter lets you choose the Dissolved Oxygen value at which the transmitter output will be 20mA.

1. Follow directions in 7.7.1 to enter Current Output mode.
2. Press the **ENTER** key until the upper display shows a Dissolved Oxygen value and the lower display shows "r.20".
3. Press the **▲** or **▼** keys to select dissolved oxygen value to be equivalent to 20 mA (Default is 8.00mg/l or 100%).
4. Press the **ENTER** key to confirm your selection and return to Advanced Set-up mode, or return to Measurement mode by pressing the **▲** and **▼** keys simultaneously (escape).

7.8 Configuration (ConF) sub-function

This group of parameters lets you configure the controller to suit your requirements.

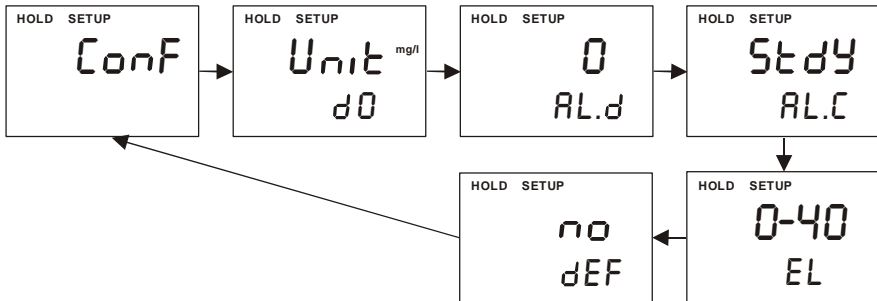

7.8.1 Entering the Configuration sub-function

1. Enter Advanced Set-up mode. Push the **ENTER** key and scroll to Advanced Set-up security code "22". Push the **ENTER** key again.
2. Press the **▲** or **▼** keys to scroll until the upper display shows "ConF".

7.8.2 Selecting the Units Of Measure (mg/l, ppm or %)

The reading displayed on the LCD in the controller can be displayed in mg/l, ppm or in terms of % saturation.

1. Follow directions in 7.8.1 to enter Configuration mode.
2. Press the ENTER key. The upper display shows "Unit" and the lower display shows "dO". By pressing the ▲ or ▼ keys, the units on the right of the upper display, toggles between the flashing "mg/l"; "ppm"; or "%".
3. After selecting the relevant units of measure, press the ENTER key to accept the selection.
4. Proceed to 7.8.3, or return to Measurement mode by pressing the ▲ or ▼ keys simultaneously (escape).

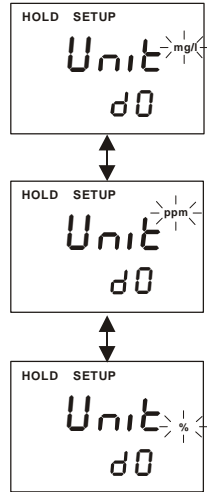

7.8.3 Selecting the Alarm Time Lag

This parameter group lets you select a period of time before the alarm activates when your set point has been overshoot. You can select from 0 to 1999 seconds.

1. Follow directions in 7.8.1 to enter Configuration mode.
2. Press the ENTER key. Scroll with the ▲ or ▼ keys until the upper display shows a numerical value (in seconds) and the lower display shows "AL.d".
3. Press the ▲ or ▼ keys to select how long of an alarm delay (0 to 1999 seconds) you want.
4. Press the ENTER key to confirm your selection.
5. Proceed to 7.8.4, or return to Measurement mode by pressing the ▲ or ▼ keys simultaneously (escape).

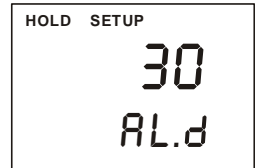

7.8.4 Selecting Steady or Pulse Contact for the Alarm Relay

This parameter group lets you select whether the alarm contact will operate as a steady contact or a fleeting (single pulse) contact. Pulse contact closing time is 250 millisecond.

1. Follow directions in 7.8.1 to enter Configuration mode.
2. Press the ENTER key. Scroll with the ▲ or ▼ keys until the upper display shows "StdY" or "FLEt" and lower display shows "AL.C".
 - AL.C = alarm contact
 - StdY = steady contact
 - FLEt = fleeting (single pulse) contact

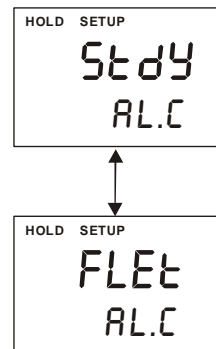

3. Press the ▲ or ▼ keys to select steady or pulse contact.
4. Press the ENTER key to confirm your selection.
5. Proceed to 7.8.5, or return to Measurement mode by pressing the ▲ and ▼ keys simultaneously (escape).

7.8.5 Selecting Dissolved Oxygen Probe Type

Note: After each changeover, the factory calibration data for zero point and slope are overwritten. Be sure to recalibrate (see section 6).

This parameter group lets you configure the controller for low range or high range probes.

1. Follow directions in 7.8.1 to enter Configuration mode.
2. Press the ENTER key until the upper display shows “0-10” or “0-40” and lower display shows “EL”.

- EL = electrode
- 0-10 = 0 to 10 ppm measurement range
- 0-40 = 0.5 to 40 ppm measurement range

3. Press the ▲ or ▼ keys to select 0-10 or 0-40 ppm range.
4. Press the ENTER key to confirm your selection.

5. Proceed to 7.8.6 step 3, or return to Measurement mode by pressing the ▲ or ▼ keys simultaneously (escape).

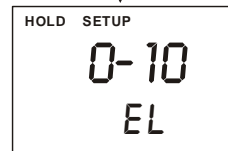
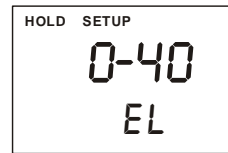

7.8.6 Reverting to Factory Default Settings

Use this parameter to reset all settings to factory default. Changing from “no” to “YES” and pressing the ENTER key resets all settings to factory default.

WARNING: If you select yes, all the settings you have made will be overwritten as a result!

1. Follow directions in 7.8.1 to enter Configuration mode.
2. Press the ENTER key. Scroll with the ▲ or ▼ keys until the upper display shows “no” or “YES”, and the lower display shows “def” (default).
3. Press the ▲ or ▼ keys to select no or yes. Selecting “YES” and pressing the ENTER key will overwrite all setting you have made and automatically return you to Measurement mode.
4. Press the ENTER key to confirm your selection and to return to Advanced Set-up mode, or return to Measurement mode by pressing the ▲ and ▼ keys simultaneously (escape).

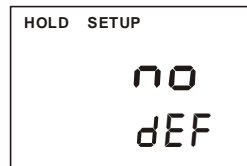

7.9 Calibration (CAL) sub-function

The calibration procedure in Advanced Set-up mode is identical to the procedure in the Calibration mode. The only difference is that the controller will revert back to Set-up mode (instead of Measurement mode) after calibration is completed.

7.9.1 Entering Calibration mode from Advanced Set-up mode

1. Enter Advanced Set-up mode. Push the **ENTER** key and scroll to Advanced Set-up security code "22". Push the **ENTER** key again.
2. Press the **▲** or **▼** keys to scroll until the upper display shows "CAL".
3. See section 6 for complete calibration procedures.

8 AUTO/MANUAL MODE

Regardless of the mode, you can control devices connected to Relay A or Relay B from the front panel of this controller. In Automatic mode, the controller's set point values activate the relays. In Manual mode, you have manual control of the relays so you can prime the pump or check pump status without operating the entire system.

8.1 Auto Mode (Mode After Switch-On)

In this mode, the controller set-point values activate the relays. To view the set-point values:

1. **Press the RELAY SELECTION (Rel A/Rel B) key.** The upper display shows your set-point value for Relay A; the lower display shows "SP1".
2. After two seconds the upper display shows your set-point value for Relay B; the lower display shows "SP2".
3. After an additional two seconds the controller will return to Measurement mode.

8.2 Manual Mode

In this mode, you can manually turn on and off the control devices connected to Relay A or Relay B or both.

1. Press the RELAY CONTROL (auto/manu) key. The upper display shows "000"; the lower display shows "S.Cd" to prompt you to enter the Advanced Set-up code.
2. Press the ▲ or ▼ keys to scroll the upper display until it reads "22".
3. Press the ENTER key. The manual indicator by the RELAY CONTROL key lights up.

Note: Pressing ENTER key at a value other than "22" will cause the controller to revert to Measurement mode, and the relays will remain in automatic mode.

4. Press the RELAY SELECTION key to select either Relay A or Relay B. The LED next to the currently selected relay (A or B) will light.
5. The manual control options are now available.
6. If you selected Limit control: The upper display reads the current measured value. The lower display shows "oFF" or "on" depending on the relay status of the currently selected relay.
7. Press the ▲ or ▼ keys to change the Relay on/off status. The LED indicators at the right of the controller will also change between Red and Green to indicate Relay status.

Note: If you wish to manually change the status of both relays, press the RELAY SELECTION key at this point and repeat step 5 for the second relay. This first relay will remain under manual control while you are setting the second relay.

8. Press the RELAY CONTROL key to return to Measurement mode. The relays are now back under automatic control.

9 TECHNICAL SPECIFICATIONS

Dissolved Oxygen Range <i>mg/l of Oxygen</i> <i>% Saturation of Oxygen</i>	0.00– 20.00mg/l 0.0 to 200.0% Saturation
Resolution <i>mg/l of Oxygen</i> <i>% Saturation of Oxygen</i>	0.01mg/l 0.1%
Relative Accuracy <i>mg/l of Oxygen</i> <i>% Saturation of Oxygen</i>	± 1.5% of full scale reading ± 1.5% of full scale reading
No. of calibration points	1 (100% Saturation) or 2 (100% and 0% Saturation) points
Flow Rate	1-2 cm/sec (dependent on both Temperature & Oxygen level)
Response Time	40-50 sec. To attain 95%
Temperature	0-50 °C (Display: -9.9 to 125 °C)
<i>Resolution</i>	0.1 °C
<i>Relative Accuracy</i>	± 0.5 °C
Sensor	Pt 100
Temperature Response	Approx. 1 min/°C
Temperature Compensation	Auto / manual (reference at 25.0 °C)
Pressure input	K.Pas/mm of Hg (Manual input and Automatic correction)
Salinity input range	0.0 to 50.0 ppt (Manual input and Automatic correction)

Set-point and Controller Functions

Controller characteristics	Limit / proportional (pulse or frequency) controller
Adjustable period with pulse length controller	0.5 to 20 sec.
Adjustable period with pulse frequency controller	60 to 120 pulses/min
Pickup / Dropout delay	0 to 1999 sec.
Switching D.O. hysteresis	0.1 to 1.0 mg/l or 0 to 10.0%
Contact outputs, controller	2 potential-free change-over contacts
Switching voltage	max. 250 VAC
Switching current	max. 3A
Switching power	max. 600 VA

Alarm Functions

Function (selectable)	Latching / pulse
Pickup delay	0 to 1999 sec.
Switching voltage	max. 250 VAC
Switching current	max. 3A
Switching power	max. 600 VA

Electrical Data and Connections

Power Requirements	110 / 220 VAC (jumper selectable)
Frequency	48 to 62 Hz
Signal Output	0/4 to 20 mA, galvanically isolated
Load	max. 600 Ω
D.O. input	screw terminals
Input impedance	10 ¹² Ω at 25°C
Cable length	5 meters
Connection terminal	Terminal blocks 5-pole / 17-pole, removable
Mains fuse / fine wire fuse	Slow-blow 250 V / 100 mA

EMC Specifications

Emissions	According to EN 50081-1
Susceptibility	According to EN 50082-1

Environmental Conditions

Ambient temp. operating range	0 to 50 °C
Relative humidity	10 to 95%, non-condensing

Mechanical Specifications

Dimensions (control panel housing - L x H x W)	175 x 96 x 96 mm
Weights (control panel housing)	max. 0.7 kg
Material	ABS with polycarbonate (front housing)
Insulation (Front / Housing)	IP 54 / IP 40

10 ACCESSORIES

10.1 Assembly Accessories

Product Description	Code No.
General Purpose DO probe, 0 – 20 ppm, with integrated Pt 100	ECDOGEN-S
Maintenance Kit for ECDOGEN-S consisting of 480 ml of electrolyte for DOGEN, membranes(Set of 5), tool for membrane housing and O rings(Set of 5)	ECDOGENKIT-S
60 ml electrolyte for DOGEN-S	01X211239
Membranes (Set of 5) for DOGEN-S	01X241605
Low Oxygen concentration DO probe, 0 – 10 ppm, with integrated Pt 100 and 5-m cable	ECDOTPII-S
Maintenance Kit for ECDOTPII-S consisting of 480 ml of electrolyte for DOTPII, membranes(Set of 5), tool for membrane housing and O rings (Set of 5)	ECDOTPIIKIT-S
60 ml electrolyte for DOTPII	01X211240
Membranes (Set of 5) for DOTPII	01X241606

11 GENERAL INFORMATION

11.1 Warranty

Thermo Scientific Instruments warrants this product to be free from significant deviations in material and workmanship for a period of one year from the date of purchase. If repair is necessary and has not been the result of abuse or misuse within the warranty period, please return by freight pre-paid and amendment will be made without any charge. Thermo Scientific Instruments' Customer Service Dept. will determine if product problem is due to deviations or customer abuse. Out of warranty products will be repaired on a charge basis.

11.2 Packaging

The instrument is packaged in a corrugated box with a warranty card, instruction manual and the following accessories:

- 17-way and 5-way (right-angled) terminal block [1 unit each]
- side threaded rod with catch [2 units]
- receptacle cable lug [1 unit]
- rubber gasket [1 unit]

11.3 Return of Goods

Authorisation must be obtained from Thermo Scientific Instruments' Customer Service Dept. to issue a RGA (Return of Goods Authorisation) number before returning items for any reason. When applying for authorisation, please include data requiring the reason of return. Items must be carefully packed to prevent damage in shipment and insured against possible damage or loss. Thermo Scientific Instruments will not be responsible for any damage resulting from careless or insufficient packing.

Warning: Shipping damage as a result of inadequate packaging is the user/distributor's responsibility, wherever applicable. Please follow the guidelines below before shipment.

11.4 Guidelines for Returning Unit for Repair

Use the original packaging material, if possible when shipping the unit for repair. Otherwise wrap it with bubble pack and use a corrugated box for better protection. Include a brief description of any faults suspected for the convenience of Customer Service Dept., if possible.

12 APPENDICES



ENSURE that the power cable is physically separated from the power supply.

12.1 Appendix 1 – Jumper Positions for 110 or 230 volts

Jumper Positions - Internal to the controller

JP 1	Selects the input voltage 220 VAC.
JP 2	Selects the input voltage 110 VAC.
Fuse	Note that there is a fuse (slow-blow 100mA) internal to the controller. Replace fuse with the recommended type only.

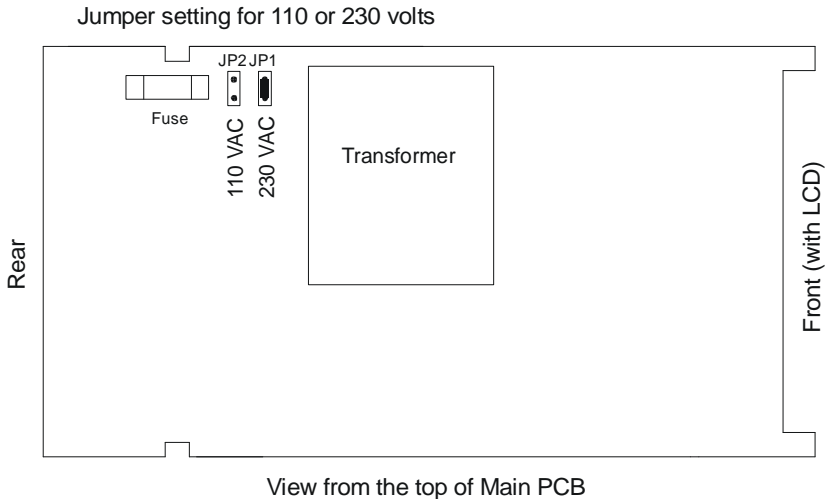

12.2 Appendix 2 – Salinity vs Temperature (@ 760 mmHg)

The following table shows the Dissolved Oxygen values at different salinity values, at different temperatures, at barometric pressure of 760 mmHg. For other pressure levels, the controller automatically corrects the value based on the pressure value input.

Temperature		Salinity- ppm				
°C	°F	0	10	20	30	40
0	32.0	14.6	13.8	13.0	12.1	11.3
1	33.8	14.2	13.4	12.6	11.8	11.0
2	35.6	13.8	13.1	12.3	11.5	10.8
3	37.4	13.4	12.7	12.0	11.2	10.5
4	39.2	13.1	12.4	11.7	11.0	10.3
5	41.0	12.7	12.1	11.4	10.7	10.0
6	42.8	12.8	11.8	11.1	10.5	9.8
7	44.6	12.1	11.5	10.9	10.2	9.6
8	46.4	11.8	11.2	10.6	10.0	9.4
9	48.2	11.5	11.0	10.4	9.8	9.2
10	50.0	11.3	10.7	10.1	9.6	9.0
11	51.8	11.0	10.5	9.9	9.4	8.8
12	53.6	10.7	10.3	9.7	9.2	8.6
13	55.4	10.5	10.1	9.5	9.0	8.5
14	57.2	10.3	9.9	9.3	8.8	8.3
15	59.0	10.1	9.7	9.1	8.6	8.1
16	60.8	9.8	9.5	9.0	8.5	8.0
17	62.6	9.6	9.3	8.8	8.3	7.8
18	64.4	9.4	9.1	8.6	8.2	7.7
19	66.2	9.2	8.8	8.5	8.0	7.6
20	68.0	9.1	8.7	8.3	7.8	7.4
21	69.8	8.9	8.6	8.1	7.7	7.3
22	71.6	8.7	8.4	8.0	7.6	7.1
23	73.4	8.6	8.3	7.9	7.4	7.0
24	75.2	8.4	8.1	7.7	7.3	6.9
25	77.0	8.2	8.0	7.6	7.2	6.7
26	78.8	8.1	7.8	7.4	7.0	6.6
27	80.6	8.0	7.7	7.3	6.9	6.5
28	82.4	7.8	7.6	7.1	6.8	6.4
29	84.2	7.7	7.4	7.0	6.6	6.3
30	86.0	7.6	7.3	6.9	6.5	6.1
31	87.8	7.4	7.1	6.7	6.4	6.0
32	89.6	7.3	7.0	6.6	6.3	5.9
33	91.4	7.2	6.9	6.5	6.2	5.8
34	93.2	7.1	6.8	6.5	6.1	5.7
35	95.0	7.0	6.7	6.4	6.0	5.6
36	96.8	6.8	6.5	6.2	5.9	5.5
37	98.6	6.7	6.4	6.1	5.8	5.4
38	100.4	6.6	6.3	6.0	5.7	5.3
39	102.2	6.5	6.3	5.9	5.6	5.2
40	104.0	6.4	6.3	5.8	5.5	5.2

12.3 Appendix 3 - Explanation on the Function of Hysteresis

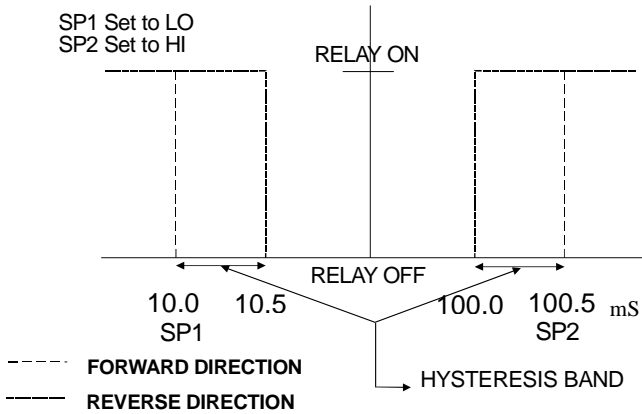

The controller relay activates when the set-point is reached. In the reverse direction, it does not de-activate when the value reaches the set-point. Instead, it continues to be active till the value reaches the amount set by the Hysteresis band.

12.4 Appendix 4 – Limit and Proportional Control Functions

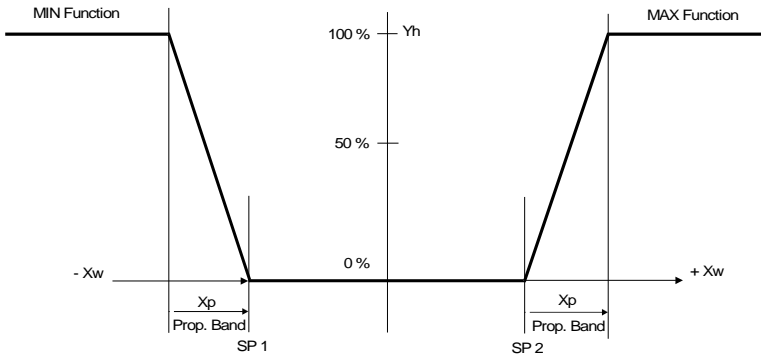

Control characteristic of P-Controllers as proportional controller

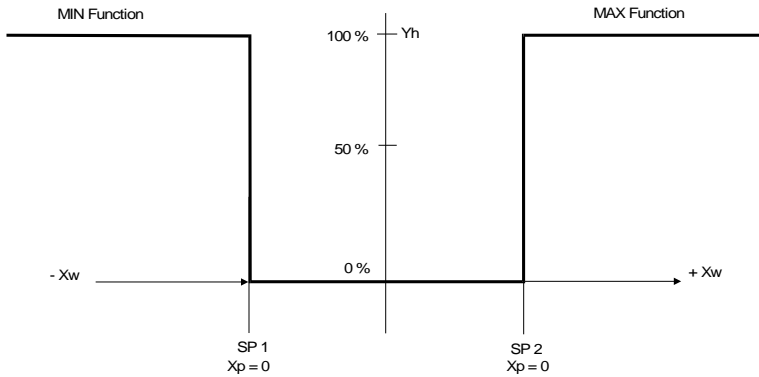

Control characteristic of P-Controllers as limit value switch

Water Analysis Instruments



North America

166 Cummings Center
Beverly, MA 01915 USA
Toll Free: 1-800-225-1480
Tel: 1-978-232-6000
Dom. Fax: 1-978-232-6015
Int'l Fax: 978-232-6031

Europe

P.O. Box 254, 3860 AG Nijkerk
Wallerstraat 125K, 3862 CN Nijkerk,
Netherlands
Tel: (31) 033-2463887
Fax: (31) 033-2460832

Asia Pacific

Blk 55, Ayer Rajah Crescent
#04-16/24, Singapore 139949
Tel: 65-6778-6876
Fax: 65-6773-0836

www.thermo.com/process

© 2009 Thermo Fisher Scientific Inc.

All rights reserved. Thermo Fisher Scientific Inc.